

POLI

Multi-Gas Detectors

MP400, MP400P, MP400S & MP400H

User's Guide



Contents

1. General Information	5
1.1 Main Features	5
2. Battery	6
2.1 Battery Charging	6
2.2 Battery Status	6
2.3 Battery Replacement	6
3. User Interface	7
3.1 Displays and Keys	7
3.2 Alarm Overview	8
4. Basic Operation.....	9
4.1 Turning On	9
4.2 Turning Off	9
4.3 Active Sensor Displays.....	10
4.4 Pump Status	10
4.5 Alarm Testing and Panic Alarm.....	10
4.6 Main User Menu	11
5. Configuration Mode.....	13
5.1 Entering Configuration Mode	13
5.2 Exiting Configuration Mode	13
5.3 Navigating Configuration Mode to Edit Parameters	14
5.4 Calibration and Bump Testing.....	17
5.5 Measurement.....	22
5.6 Alarm Settings.....	23
5.7 Datalog	24
5.8 Monitor Set-up.....	25
5.9 Wireless Set-up (mSquad and mPlatoon)	27
6. Data Communication	28
6.1 Connecting and Configuring	28
6.2 Datalog and Event Retrieval	31
6.3 Real-Time Data	33
7. POLI MonoDock Operation	34
7.1 MonoDock Cal/Bump Procedures	34
7.2 MonoDock Data Download and Calibration Certificates	35
8. Maintenance.....	36
8.1 Replacing Filters.....	36
8.2 Removing or Replacing Sensor Modules	37
8.3 Cleaning or Changing PID Sensor Detector or Lamp	38
8.4 Replacing Pump or Battery	38
9. Troubleshooting.....	39
10. Technical Specifications	40
Recommended Gas Span Concentrations	41
Technical Support and mPower Contacts.....	42

Read Before Operating

This manual must be carefully read by all individuals who have or will have the responsibility of using, maintaining or servicing this product. The product will perform as designed only if it is used, maintained and serviced in accordance with the manufacturer's instructions. The user should understand how to set the correct parameters and interpret the obtained results.

CAUTION !

- REMOVE MONITOR COVER ONLY IN AREA KNOWN TO BE NON-HAZARDOUS.
- RECHARGE BATTERY ONLY IN AN AREA KNOWN TO BE NON- HAZARDOUS.
- USE ONLY mPOWER'S RECHARGEABLE LITHIUM BATTERY P/N M004-3002-000.
- USE OF NON-mPOWER COMPONENTS WILL VOID THE WARRANTY AND CAN COMPROMISE THE SAFE PERFORMANCE OF THIS PRODUCT
- SUBSTITUTION OF COMPONENTS MAY IMPACT INTRINSIC SAFETY.

CAUTION: HIGH OFF-SCALE READINGS MAY INDICATE AN EXPLOSIVE CONCENTRATION. ANY RAPID UP-SCALE READING FOLLOWED BY A DECLINING OR ERRATIC READING MAY INDICATE A GAS CONCENTRATION BEYOND UPPER SCALE LIMIT WHICH MAY BE HAZARDOUS.

ATTENTION: DES LECTURES SUPÉRIEURES A L'ÉCHELLE PEUVENT INDIQUER DES CONCENTRATIONS EXPLOSIVES. TOUTE LECTURE RAPIDE ET POSITIVE, SUIVIE D'UNE BAISSSE SUBITE AU ERRATIQUE DE LA VALEUR, PEUT INDIQUER UNE CONCENTRATION DE GAZ HORS GAMME DE DÉTECTION QUI PEUT ÊTRE DANGEREUSE.

WARNINGS !

ONLY THE COMBUSTIBLE GAS DETECTION PORTION OF THIS INSTRUMENT HAS BEEN ASSESSED FOR PERFORMANCE.

UNIQUEMENT, LA PORTION POUR DÉTECTOR LES GAZ COMBUSTIBLES DE CET INSTRUMENT A ÉTÉ ÉVALUÉE.

CAUTION: BEFORE EACH DAY'S USE, THE SENSITIVITY OF THE COMBUSTIBLE GAS SENSOR MUST BE TESTED ON A KNOWN CONCENTRATION OF METHANE GAS EQUIVALENT TO 20 TO 50% OF FULLSCALE CONCENTRATION. ACCURACY MUST BE WITHIN 0 AND +20% OF ACTUAL. ACCURACY MAY BE CORRECTED BY A CALIBRATION PROCEDURE.

ATTENTION: AVANT CHAQUE UTILISATION JOURNALIERE VERIFIER LA SENSIBILITE AVEC UNE CONCENTRATION CONNUE DE METHANE EQUIVALENTE A 20-50% DE LA PLEINE ECHELLE. LA PRECISION DOIT ETRE COMPRISE ENTRE 0-20% DE LA VALEUR VRAIE ET PEUT ETRE CORRIGEE PARUNE PROCEDURE D'ETALONNAGE.

⚠ WARNINGS !

This device complies with part 15 of the FCC Rules. Operation is subject to the following two conditions: (1) This device may not cause harmful interference, and (2) this device must accept any interference received, including interference that may cause undesired operation.

CAUTION: Changes or modifications to this unit not expressly approved by the party responsible for compliance could void the user's authority to operate the equipment.

NOTE: This equipment has been tested and found to comply with the limits for a Class B digital device, pursuant to part 15 of the FCC Rules. These limits are designed to provide reasonable protection against harmful interference in a residential installation. This equipment generates, uses and can radiate radio frequency energy and, if not installed and used in accordance with the instructions, may cause harmful interference to radio communications. However, there is no guarantee that interference will not occur in a particular installation. If this equipment does cause harmful interference to radio or television reception, which can be determined by turning the equipment off and on, the user is encouraged to try to correct the interference by one or more of the following measures:

- Reorient or relocate the receiving antenna.
- Increase the separation between the equipment and receiver.
- Connect the equipment into an outlet on a circuit different from that to which the receiver is connected.
- Consult the dealer or an experienced radio/TV technician for help.

Special Conditions for Safe Use

- The POLI multi-gas detector must be calibrated if it does not pass a bump test, when a new sensor has been installed, or at least once every 180 days, depending on use and sensor exposure to poisons and contaminants
- No precautions against electrostatic discharge are necessary for portable equipment that has an enclosure made of plastic, metal or a combination of the two, except where a significant static-generating mechanism has been identified. Activities such as placing the item on a belt, operating a keypad or cleaning with a damp cloth, do not present a significant electrostatic risk. However, where a static-generating mechanism is identified, such as repeated brushing against clothing, then suitable precautions shall be taken, e.g., the use of anti-static footwear.

Note: Users are recommended to refer to ISA -RP12.13, Part II-1987 for general information on installation, operation, and maintenance of combustible gas detection instruments.

Proper Product Disposal at the End of Life



The Waste Electrical and Electronic Equipment (WEEE) directive (2002/96/EC) is intended to promote recycling of electrical and electronic equipment and their components at end of life. This symbol (crossed-out wheeled bin) indicates separate collection of waste electrical and electronic equipment in the EU countries. This product may contain one or more Nickel-metal hydride (NiMH), Lithium-ion, or Alkaline batteries. Specific battery information is given in this user guide. Batteries must be recycled or disposed of properly. At the end of its life, this product must undergo separate collection and recycling from general or household waste. Please use the return and collection system available in your country for the disposal of this product.

1. General Information

The POLI multi-gas detectors (MP400 & MP400P) offer 4- or 5-gas monitoring of oxygen (O₂), combustible (LEL) gases, toxic gases, carbon dioxide (CO₂), and volatile organic compounds (VOCs). The MP400 is a diffusion sampling model with standard O₂, LEL, carbon monoxide (CO) and hydrogen sulfide (H₂S) configuration. A firefighter version uses O₂, LEL, CO and hydrogen cyanide (HCN) sensors, and a 5-gas version including sulfur dioxide (SO₂) is also available. The MP400P is a standard model with pump and allows a full selection of sensors, e.g. over 30 different electrochemical (EC) sensors, pellistor for LEL, non-dispersive infrared (NDIR) for hydrocarbons in both %LEL and %Vol ranges and photo-ionization detector (PID) for VOCs.

The MP400S is an advanced model with pump and a built-in wireless module that sends critical data including panic, man-down, gas concentration, and battery alarms to supervisors and control centers on site or at remote locations for faster responses and maximized safety. The MP400S is used in concert with a head monitor MP400H for teams of up to 8 monitors in an mSquad are up to 64 monitors in an mPlatoon system. This User Guide covers the basic operation of the individual MP400S and MP400H instruments; for information on setting up and operating systems of multiple instruments, see the mSquad User's Guide.

1.1 Main Features

- 4 models of diffusion, pumped and wireless optimized for basic confined space entry (CSE) compliance, professional, and advanced applications
- Large, graphical display and icon-driven user interface through intuitive, simple, two-button operation. Auto flip-screen when held up-side down.
- Over 30 interchangeable sensor configurations, including PID for VOC, NDIR and catalytic sensor for combustibles, and NDIR for CO₂
- Intelligent sensors store calibration data ready for quick installation in the field
- Easy access to pump, sensors and filter
- Long battery run time of 16 hours in diffusion mode and 12 hours with pump running
- 6 months continuous datalog storage with 4 sensors
- Man-down, panic, gas concentration and battery alarm notification via ISM wireless at no operating cost
- IP-65/67 water and dust resistant rating
- Durable double-shot outer case

NOTE

Due to continuous improvement of our products, this manual may not reflect all of the latest updates in software, firmware and hardware for the instrument received.

2. Battery

Fully charge the POLI battery upon receiving the instrument and before each day's use. The Li-ion battery is charged using a Micro-USB cable.

NOTE: Any locally-obtained USB A to Micro B USB cable works for charging, but does not work for communication with mPower Suite configuration and data transfer software. The mPower USB cable P/N M-011-3003-000 is required for a PC to recognize the instrument and communicate with mPower Suite.

WARNING

To reduce the risk of ignition of hazardous atmospheres, recharge, remove or replace the battery only in an area known to be non-hazardous!



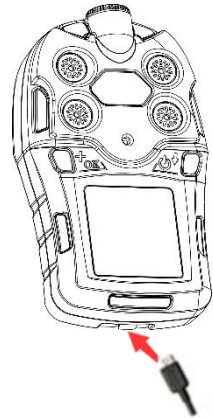

2.1 Battery Charging

Plug the mini end of the Micro-USB cable into the charging port of POLI, and the other end to a USB power adaptor or the USB port of a computer. The screen will display a battery icon from empty to full and one alarm LED will remain yellow. When the battery is fully charged, the icon displays full grid status (see Section 3.1), and the alarm LED turns green.



2.2 Battery Status

The battery icon on the display shows how much charge is in the battery, and alerts of any charging problem.

				 blink
Full charge	2/3 charge	1/3 charge	Battery Low	Battery Alarm

When the battery's charge falls below a preset voltage, the instrument warns by beeping once and flashing once every minute. The instrument automatically powers down within 10 minutes, after which the battery must be recharged. When a low-battery alarm occurs, we recommended promptly switching instruments to a fully charged POLI, and/or charging the battery in a non-hazardous location.

2.3 Battery Replacement

The POLI Lithium-ion battery pack is free of maintenance. In case of a battery failure or end of operating life, please contact the mPower Service Department or an authorized service center for a battery replacement.

3. User Interface

The POLI user interface consists of two keys, four sensor sockets, one large Liquid Crystal Display (LCD), eight alarm LEDs, one buzzer, and two vibration alarms.

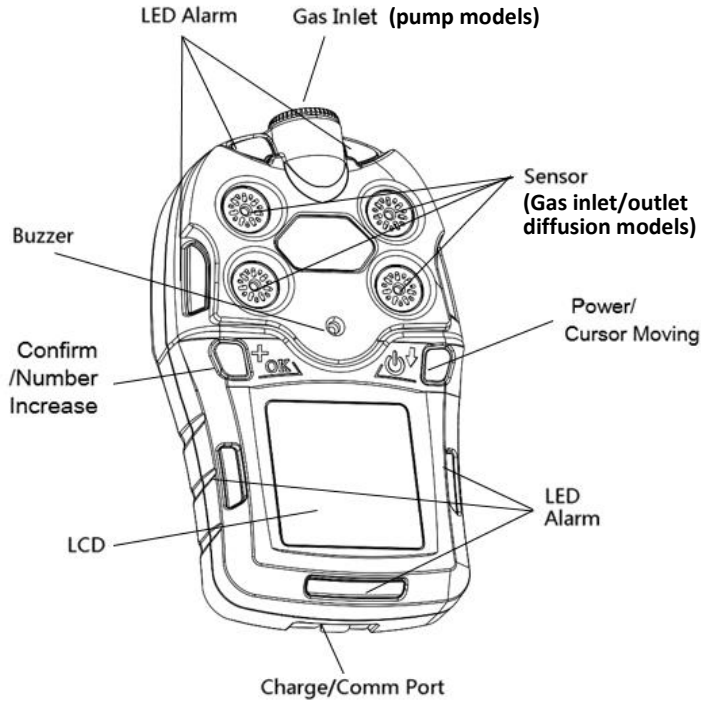





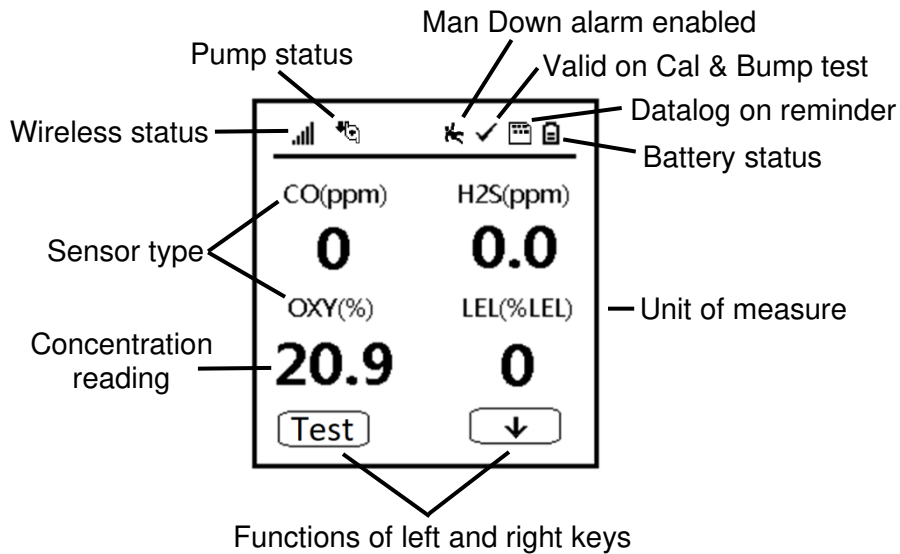

3.1 Displays and Keys

The LCD provides visual information that includes real-time gas readings, sensor types, datalog / battery / pump / wireless status, and others.



3.1.1 Status Indicator Icons

Along the top of most screens are status icons that indicate whether a function is operating and/or its strength or level.

Icon	Function
	Wireless signal strength at 0-5 level
	Pump status (pump versions only)
	Datalogging enabled (cannot turn off)
	Battery voltage status
	Man-down alarm enabled
	All sensors have been bump tested and calibrated; no sensor is overdue for a bump test or calibration according to the intervals configured on the instrument.

3.1.2 Keys and Interface

The POLI has two keys:



Left [+ / OK] Key
Confirm Operation/Increase Number

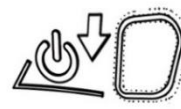

Right [Power / Down Arrow] Key
Power On-Off/Move Cursor

These two keys are marked as [+ / OK] to Confirm Operations or Increase Number and [Power / Down Arrow] to Power On-Off / Move Cursor. They also act as ‘soft keys’ mapped to two text or symbol boxes at the LCD bottom that change numbers and make selections under various menus.

In addition to the functions described above, the Left [+ / OK] key can be used to manually activate the LCD backlight when it is off, and to manually test the LED, audio and vibration alarms from the main display.

3.2 Alarm Overview

The POLI provides an unmistakable five-way alarm notification that combines local alarms on the device with real-time remote wireless alarm notification to enhance worker safety up to the next level. Device alarms include audible buzzer, visible bright LED lights, vibration, and alarm notification on the display. These can be programmed or selectively turned on or off.

During each measurement period, the gas concentration is compared with the programmed alarm limits for Low, High, TWA and STEL alarms. If the concentration exceeds (or goes below, in the case of oxygen) any of the preset limits, the alarms are activated immediately to warn both the POLI user and a remote safety officer (if wireless is enabled) of the alarm condition. In addition, the POLI alarms when the battery voltage is low, pump is blocked, and in other fault conditions.

A major new feature is the Man-Down detection, which can be enabled to activate local and remote alarms when the user has collapsed or stopped moving. This feature can also be initiated manually by initiating a Panic Alarm if the worker finds themselves in distress.

Alarm Types and Priority

Alarm Type	Red LED	Buzzer	Vibrator
Panic Alarm	1 Flash/sec	Multi-Tone Long Beep	1 Vibration/sec
Man-Down Alarm	1 Flash/sec	Multi-Tone Long Beep	1 Vibration/sec
Over-range Alarm	3 Flashes/sec	3 Beeps/sec	1 Vibration/sec
High Gas Alarm	3 Flashes/sec	3 Beeps/sec	1 Vibration/sec
Calibration Fail	3 Flashes/sec	3 Beeps/sec	1 Vibration/sec
Bump Test Fail	3 Flashes/sec	3 Beeps/sec	1 Vibration/sec
Low Gas Alarm	2 Flashes/sec	2 Beeps/sec	1 Vibration/sec
STEL Alarm	1 Flash/sec	1 Beep/sec	1 Vibration/sec
TWA Alarm	1 Flash/sec	1 Beep/sec	1 Vibration/sec
Negative Drift	1 Flash/sec	1 Beep/sec	1 Vibration/sec
Calibration Overdue	1 Flash/sec	1 Beep/sec	1 Vibration/sec
Bump Test Overdue	1 Flash/sec	1 Beep/sec	1 Vibration/sec
Battery Low	1 Flash/min	1 Beep/min	1 Vibration/min
Sensor Error	1 Flash/sec	1 Beep/sec	
Battery Dead	1 Flash/sec	1 Beep/sec	
Wireless Comm Lost	1 Flash/sec		

Priority (Highest to Lowest) ↓

4. Basic Operation

4.1 Turning On

Press and hold the [⏻/↓] Key for 3 seconds, until the buzzer beeps and the red LED turns on. As the unit is powered on, it will display information such as mPower logo and Company name, Product type, Model No. and Serial No., Firmware version, Build date and time, Battery type and Voltage, Datalog interval and Alarm Limits for each Sensor type.

The POLI's main reading screen then appears. It usually takes 1 to 2 minutes for sensors to show meaningful readings. For some sensors not fully warmed up by the time, the main screen shows '- -' instead of numerical values until the sensor is stabilized, typically in a few more minutes. It then displays instantaneous readings similar to the screens shown in Section 2.2 (depending on the sensors installed) and is ready for use.

NOTE: If the battery has too low power, a message 'Battery Fully Discharged' is briefly shown and the POLI shuts off automatically. The battery should then be recharged before restarting. If a major error that prevents the POLI from functioning occurs during startup, the message 'Contact Service' is displayed. The instrument should be shut off and sent for service.

4.2 Turning Off

In normal reading mode, press and hold the [⏻/↓] key. The unit will show a 5-second count down, with red LED flashes and buzzer beeps once per second. After the last long flash and beep, the unit displays 'Power Off', and turns off.

Caution: The alarm is loud. During startup, one can mute most of the sound by temporarily holding a finger over the buzzer opening hole. Do not put tape over the buzzer opening as it permanently mutes and causes a serious safety concern.

4.3 Active Sensor Displays

The POLI is a flexible platform with four sensor sockets that allows use of anywhere between one and five sensors, the latter with a dual toxic gas sensor. When one or more sensors is either not installed or turned off, the display only shows the installed, active sensors:



One Sensor

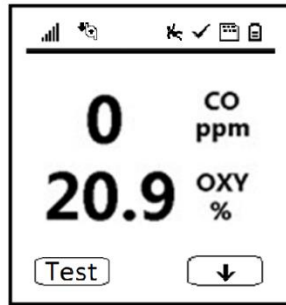

Two Sensors

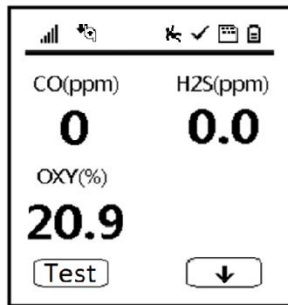

Three Sensors

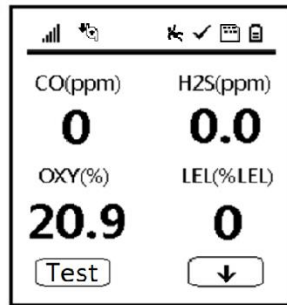

Four Sensors

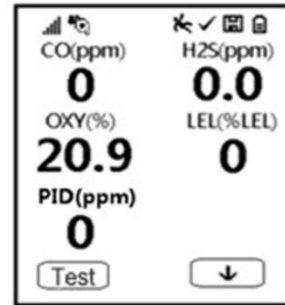

Five Sensors

4.4 Pump Status

During normal operation, the pump icon alternately shows inflow and outflow. If there is a pump failure or obstruction, the alarm sounds and the pump stall icon blinks on and off. If this occurs, clear the obstruction and press the Left [+ /OK] key to restart the pump.



IMPORTANT!

Obstructions can cause premature wear on the pump and false readings. If the pump does not restart after pressing [+ /OK], consult the Troubleshooting section of this guide or contact an mPower service center for technical support.

NOTE: Pump status is not indicated on diffusion versions of the POLI.

4.5 Alarm Testing and Panic Alarm

Under normal operation mode and non-alarm conditions, the audible (buzzer) alarm, vibration alarm, LED, and backlight can be tested at any time by pressing [+ /OK] once. Continuing to hold down the [+ /OK] key for 3 seconds initiates a Panic Alarm that warns nearby workers of the operator's distress. This alarm can be cleared by holding down both keys simultaneously.

⚠ WARNING!

If any of the alarms do not respond to this test, check the Alarm Settings in Configuration Mode to see if the alarms have been turned off. If any of the alarms is enabled but not functional, do not use the instrument. Contact an mPower service center for technical support.

4.6 Main User Menu

There are two main menus accessible without a password directly from the main concentration display screen. Repeatedly pressing the Right [⏏/↓] key cycles through various parameters such as the latest Peak and TWA readings, date, battery status, and gas correction factors. The Left [+ / OK] key cycles through the Bump and Calibration status of the monitor.

4.6.1 Right-Cycle Main Menu

The Right-cycle information sequence is shown below. The Peak, Minimum, STEL and TWA for each sensor since turn-on are displayed, with the option to clear and re-start Peak or Minimum. The date, time, temperature and battery information are self-explanatory. If the POLI is fitted with a PID or Pellistor LEL sensor, the corresponding Calibration Gas and Measurement Gas (and its Correction Factor) are displayed (can be changed in mPower Suite).

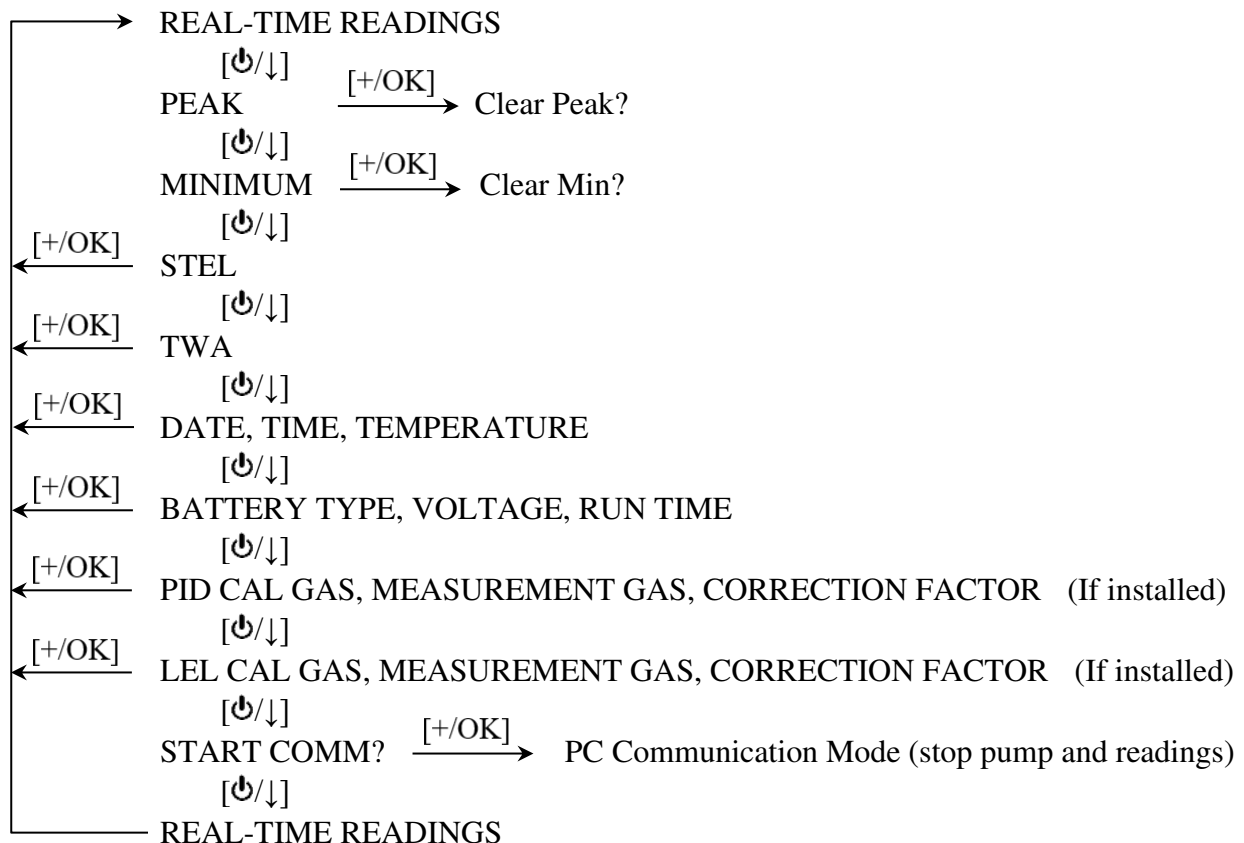

The last display before returning to Real time readings is “Start Comm?”. Pressing the check box stops the pump and readings, and waits for communication with a PC using mPower Suite to transfer data or update the instrument configuration (see Section 6).

4.6.2 Left-Cycle Main Menu

The Left-cycle information sequence is shown below.

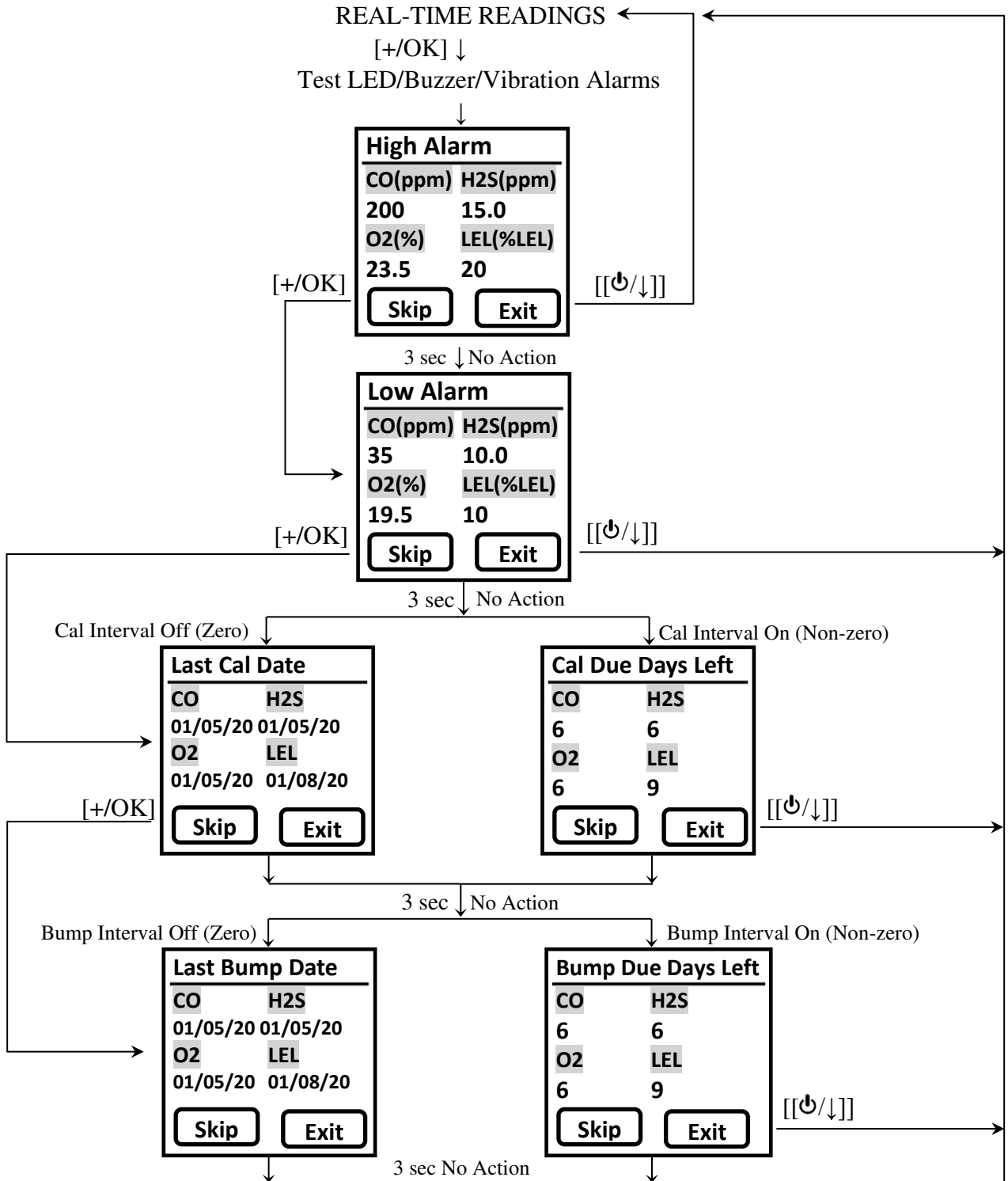

Pressing the Left [+ /OK] key once first tests all the alarms and then automatically cycles through displaying the High and Low Alarm Limits and Cal and Bump information for all the sensors installed. If the Cal or Bump intervals are turned off (set to zero), the last Cal or Bump Dates are shown. If the Cal or Bump intervals are given set values, then the days remaining until due are shown. Any screen can be skipped without waiting the 3 seconds by pressing the Left [+ /OK] key or the whole process exited using the Right [↵] key.



5. Configuration Mode

The Configuration Mode (Config Mode) is used to adjust the POLI's operation settings and calibrate sensors. Remember that the two text/symbol boxes at the bottom of the display are mapped to the Left [+ /OK] and Right [↵] keys and will vary with the menu.

5.1 Entering Configuration Mode

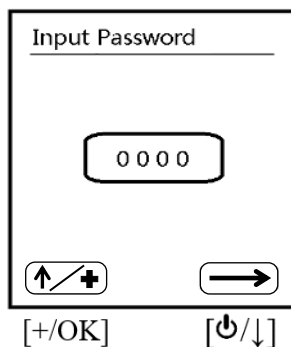
Press and hold both the [+ /OK] and [↵] keys simultaneously for 3 seconds until the password screen appears. The default password is '0000' and can only be changed using mPower Suite software. The password is needed only the first time Config Mode is entered after power is turned on.



- Increase the number from 0 through 9 by pressing [+ /OK] (mapped to .
- Step from digit to digit using [↵] (mapped to .
- After entering all four digits, Press [↵] again and  changes to '✓'.
- Press [+ /OK] to register the password and enter Config Mode.

If the password is not correct, the message 'Incorrect!' is displayed and the unit returns to the reading mode automatically. If a wrong digit is entered, use the [↵] key to move the cursor among four digits and press [+ /OK] to change the input.

5.2 Exiting Configuration Mode

To exit, scroll through the main Config Mode Menu using the [↵]  key until the door symbol is highlighted and press [+ /OK]. Or simply wait, and the unit will return to normal operating mode automatically if no buttons are pressed for one minute.



5.3 Navigating Configuration Mode to Edit Parameters

After entering Config Mode, the calibration menu is displayed first. Press [⏻/↓] (→) to step through the menus and [+ /OK] (Enter) to enter a menu to edit the parameters in its submenu.

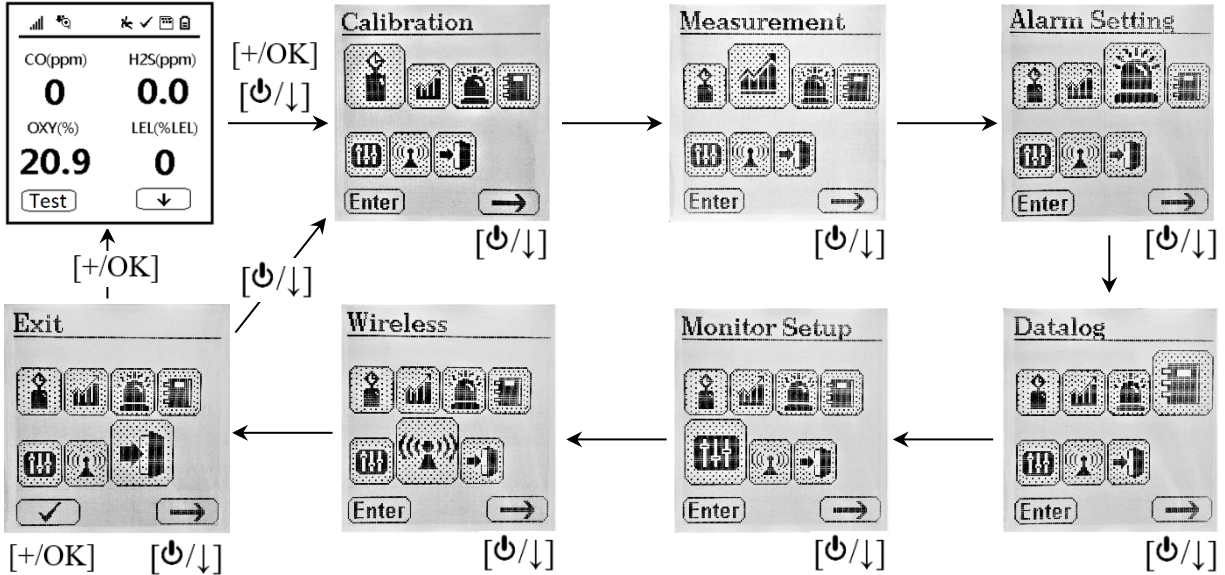

5.3.1 Menus and Sub-menus

Configuration Mode menus and sub-menus are organized as shown here:

Calibration	Measurement	Alarm	Datalog	Monitor Setup	Wireless**	Exit
Fresh Air Calib	Enable/Disable	High Limit	Clear All	LCD Contrast	Register Devices	
Multi Span	PID Meas. Gas [‡]	Low Limit	Interval	Pump Speed*	Assign Worker	
Single Zero (for O ₂ /CO ₂ only)	Set User CF (PID only) [‡]	STEL Limit	Sensor Select	Pump Stall*	Register (for 400H only)	
Single Span	Gas Unit	TWA Limit	Exit	Temperature Unit	Host Module ID	
Bump Test	Exit	Alarm Device		Language	Channel	
Set Span Value		Heart Beat Light		Back Light Mode	Exit	
Set Span2 Val [¥]		M-D [†] On/Off		LCD Auto Flip		
3-Point Cal Enable [¥]		Man-Down Warn Time		Policy Check		
Exit		Man-Down Threshold		Real-Time Clock Set-up		
		Man-Down Tmotionless		Exit		
		Exit				

* Pump versions only. ** Wireless versions only. †PID versions only. ¥PID & Dual-range LEL versions only †M-D = Man-Down

5.3.2 Navigating Lists

There are two types of menus in Configuration Mode: 1) those that ask for selection from a list and 2) those that ask for a numerical value to be entered. Simple lists and those with radio buttons are used when only one option can be selected. Check [X] boxes are used when multiple options can be selected at the same time.

5.3.2.1 Simple Lists

When a simple list is shown, use the [⏏/↓] down-arrow key to highlight the desired item and then press [+ / OK] (Enter) to enter the sub-menu. To exit the simple list, scroll down until Exit is highlighted and the Enter key changes to '✓', then press [+ / OK].

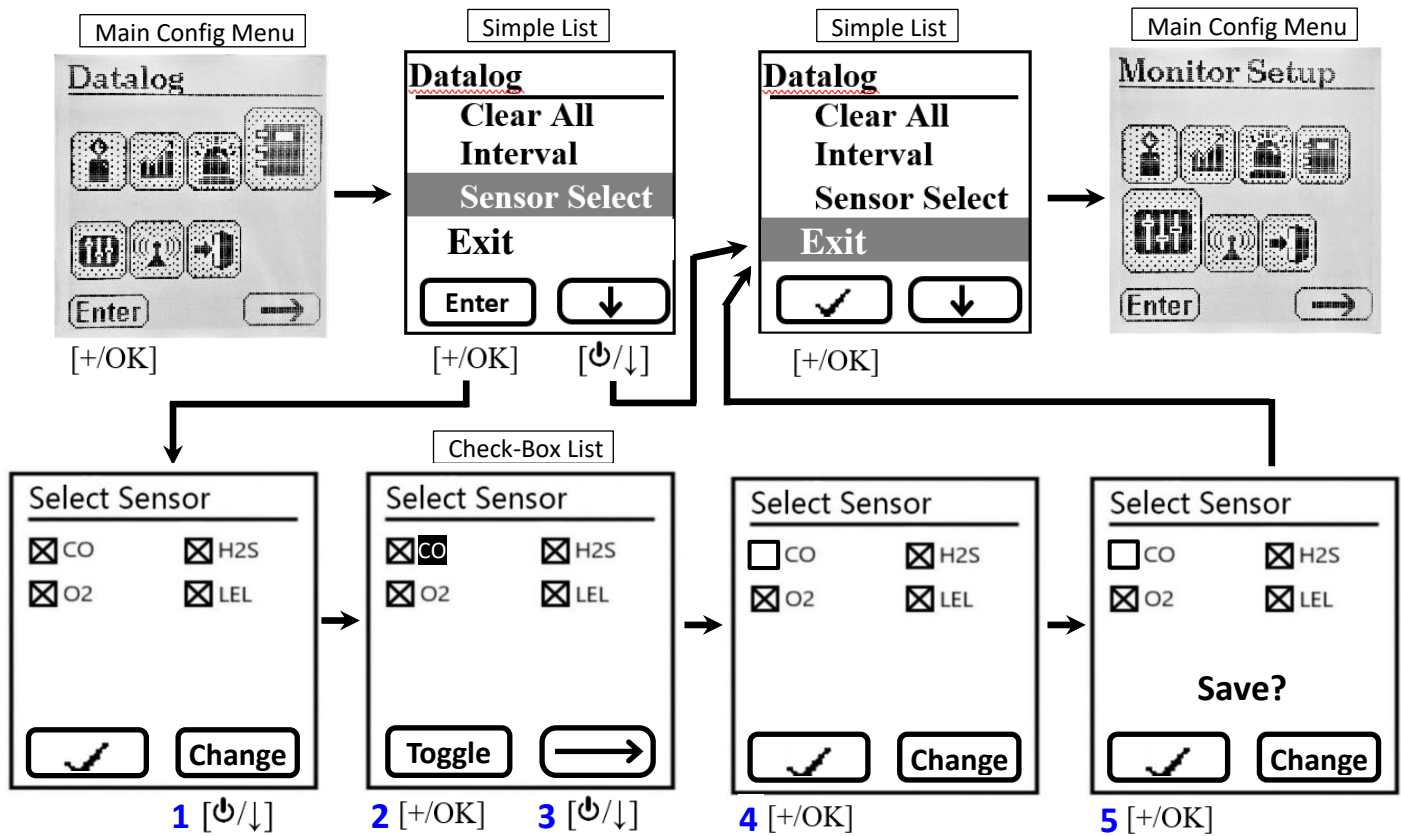

5.3.2.2 Check [X] Box Lists

When a Check [X] Box list appears as shown above, follow the numbered sequence in **blue** above. If no change is desired, simply press [+ / OK] '✓' to exit. To make changes, **1** press [⏏/↓] and the first item is highlighted. **2** Use [+ / OK] to toggle the item checked or unchecked, and **3** use the arrow [⏏/↓] to move to the next item or end of the list where (Toggle) changes to '✓'. Finally, **5** press [+ / OK] '✓' to exit and **6** press [+ / OK] '✓' again to save. If Save is not acknowledged, no changes will be made and the unit will revert back to the previous settings.

5.3.2.3 Radio Button Lists

Radio buttons are used when only a single item in the list can be selected, and there are no further sub-menus. When a radio button list appears, follow the numbered sequence in blue as shown below. If no change is desired, simply press [+ / OK] '✓' to exit. To make changes, **1** press [✓ / ↓] (Change) and the first item is highlighted. **2** Use the down arrow [✓ / ↓] to move to the desired item, **3** use [+ / OK] (Select) to choose the highlighted item, and **4** use the down arrow [✓ / ↓] to move to the next item or end of the list where (Select) changes to '✓'. Finally, **5** press [+ / OK] '✓' to exit.

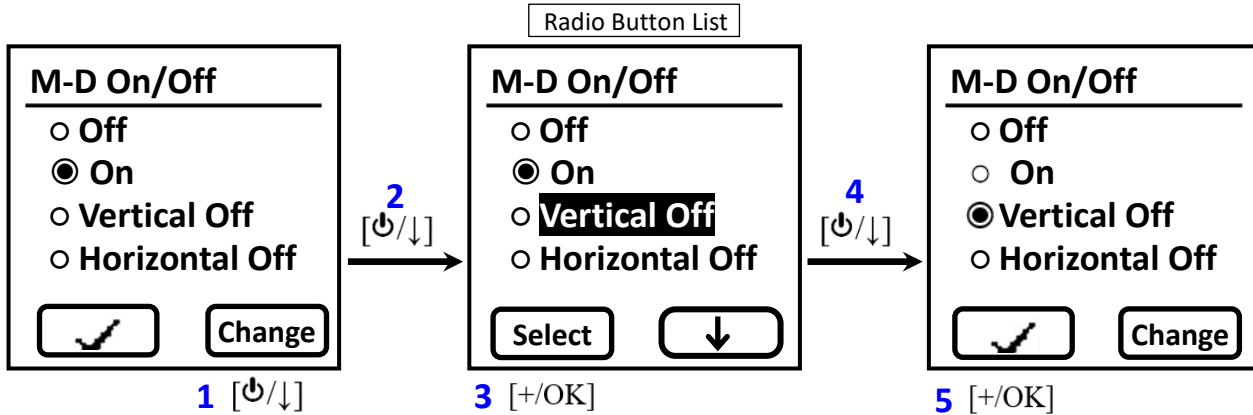

5.3.3 Entering Numerical Values

To enter numerical values in a list, proceed as shown below. If no change is desired, simply press [+ / OK] (Done) to exit. To make changes, press [✓ / ↓] (Change) and the first item is highlighted. Use the arrow [✓ / ↓] to move to the desired item(s), use [+ / OK] (Inc / +) to increase the numerical value. Then use the arrow [✓ / ↓] to move to the next item or end of the list where (Inc / +) changes to (Done). Finally, press [+ / OK] (Done) to exit and press [+ / OK] (Done) again to save. If Save is not acknowledged, no changes will be made and the unit will revert back to the previous settings

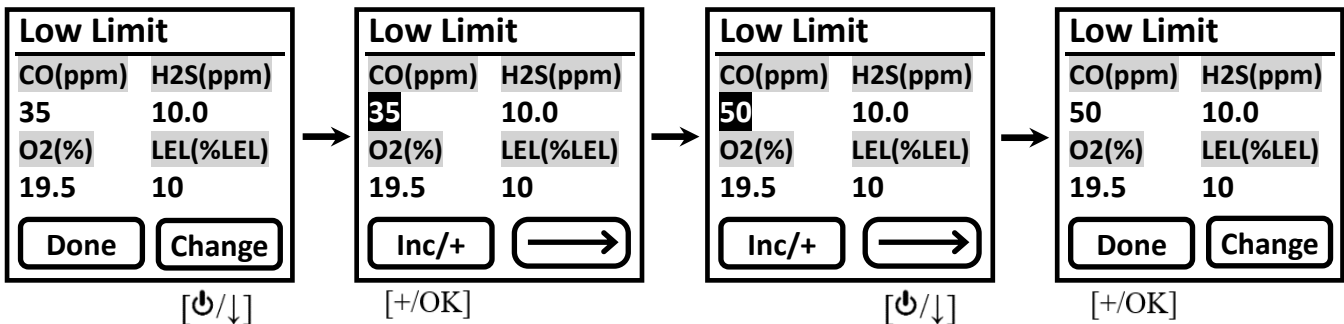

5.3.3.1 Decreasing Numerical Values

To switch the Left soft key function from increasing to decreasing, hold both keys down simultaneously for about 2 seconds until **Inc / +** changes to **Dec / -**. After exiting the menu, the Left key will automatically revert to increasing numbers again.

5.4 Calibration and Bump Testing

Use this menu to perform zero or span calibration for one or more sensors, bump test the sensors and alarms for function, and change the span gas concentration.

The POLI should be calibrated on the first day of use and at regular intervals not to exceed 180 days, depending on use and exposure to particulates, contaminants and sensor poisons. A daily bump test should be performed to ensure a functional response of all sensors and alarms.

- **BUMP TEST** is defined as a brief exposure to sensor gases, typically 30 seconds, just long enough to indicate that the sensors are responsive and the alarms are functional, without concern for a quantitative measurement.
- **CALIBRATION** is defined as exposing the sensor(s) to a known concentration standard gas for the full calibration time (typically 60 to 90 seconds) and setting the reading of the sensor(s) equal to the concentration of the calibration gas.

Calibration intervals and bump test procedures may vary due to sensor type, ambient conditions, local regulations and/or the user's company policies.* Automatic reminders for calibration and bump tests can be set up using the mPower Suite software (see Section 6.1). When a calibration or bump is due, the sensor name alternates with a highlighted 'CAL' or 'BUMP' as shown below:

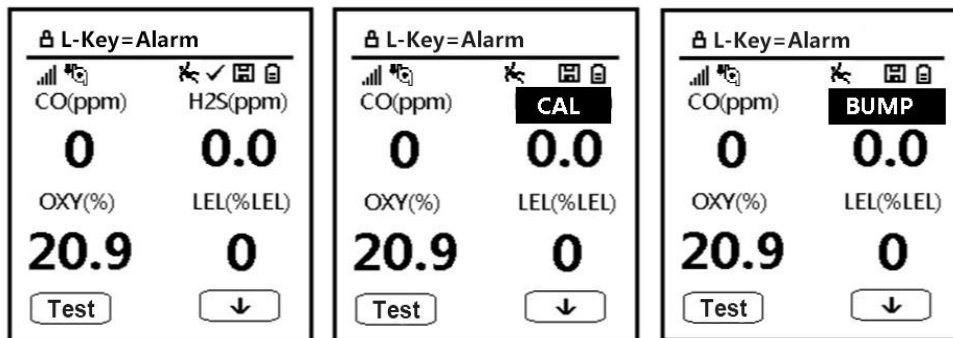

Calibration is also required if:

- The sensor module has been replaced with one whose calibration is overdue.
- The user has changed the calibration gas type without recalibrating the instrument.
- The sensor has failed in a previous calibration.

For more on calibration frequency see Tech/App Note 3 “How Often to Calibrate Gas Detectors”.*

* The calibration frequency must be defined by the user's company policy because each application is different and may cause a sensor's sensitivity loss for various reasons out of mPower's control, such as liquids, dirt or corrosion preventing gas from reaching a sensor, or exposure to chemicals that poison a sensor's function. Exotic gas sensors tend to need more frequent calibration than common O₂, LEL, CO and H₂S sensors. In general we recommend a bump test before each day's use to test sensor response and alarm function. A calibration check can be performed by applying a known concentration gas to see if the sensors still respond within typical limits. Cal check intervals can be increased as the user gains experience in the application. If a bump or cal check fails, the instrument should be given a full calibration. We recommend no more than one month between full calibrations, but this can be extended for up to 6 months if company policy allows.

5.4.1 Calibration Set-Up

5.4.1.1 Span Gas Selection

The gas concentration chosen for span calibration and bump testing should be near the middle to upper range of the concentrations expected to be measured. If the possible gas concentrations are unknown, choose a gas concentration near the upper end of the sensor's range, or near the highest exposure limit (e.g., TWA, STEL or Ceiling) of concern. Standard 4-gas mixtures allow calibration of 4 sensors at the same time. mPower has selected a mixture of 60 ppm CO/15 ppm H₂S/2.5% CH₄/18% O₂, (balance N₂) as the recommended calibration gas for such monitors. Span gas recommendations for other gases are listed at the end of this manual and in TA Note 4. Some sensors can be calibrated with surrogate gases when the gas they are designed to measure is highly reactive, expensive or otherwise difficult to obtain.

Note that some common sensor combinations use calibration gases that are incompatible and therefore must be applied separately, for example chlorine (Cl₂) & ammonia (NH₃) and chlorine dioxide (ClO₂) and hydrogen sulfide (H₂S). For such cases it is important to allow a few minutes between calibrations to allow one interfering gas to clear out before the other is applied.

5.4.1.2 Calibration Compounds for PID and LEL Sensors

Because PIDs and LEL sensors are broadband detectors, they can be calibrated with many possible gases. The type of calibration gas is selected from a list of several hundred compounds in mPower Suite (Section 6.1), typically isobutylene for PID and methane for LEL. The measurement gas is also selected in mPower Suite. Correction factors are calculated and automatically applied to make the display read in equivalents of the Measurement Gas.

5.4.1.3 Gas Connections and Regulators

Calibration gas is most easily supplied from a pressurized cylinder controlled by a regulator.

- **Fixed-flow Regulators** are pre-set to deliver a consistent flow rate regardless of the gas pressure remaining in the cylinder. We recommend 0.3 LPM regulators for diffusion POLI versions and 0.5 LPM regulators for pumped POLI versions.
- **Demand-flow Regulators** are more expensive but save gas by allowing only the amount of gas to flow that the POLI pump withdraws. These regulators cannot be used with diffusion instruments since they have no pump.
- **Gas Generators** provide their own flow and are required for a few gases like ozone (O₃) and chlorine dioxide (ClO₂) that are too unstable to be stored in a cylinder.
- **Trigger Regulators** supply a puff of gas at an undefined flow and are useful for quickly doing a functional bump test without entering Config Mode to record the test.

Pumped Instruments. We recommend calibrating the POLI with the pump on the High Flow setting, where it typically draws less than 450 cc/min (0.45 LPM) with a 0.45 µm filter in place. In this case the instrument can be connected directly to the gas cylinder fitted with either a demand-flow regulator or a 0.5 LPM fixed flow regulator. If the fixed-flow regulator supplies more than 0.5 LPM, a T-connector, as illustrated below, must be used in the gas supply line to allow excess gas to escape without being forced through the POLI pump and sensor chambers. Even when using a T-connector, we recommend no more than 1.0 LPM total flow.

Note: Make sure the pressure in the gas cylinder is >100 psi when using a T-connector.



Diffusion Instruments. Diffusion instruments have a black cap covering the Luer connector to protect the unit from dirt and moisture. This cap must be removed to attach the Luer fitting and connected tubing leading to the gas supply. (Internal channels distribute the gas to each sensor, even though during measurements the gas enters and leaves through the four filters on the face of the POLI.) The gas flow should be low, between 0.2 and 0.3 LPM to avoid pressure build-up in the sensor channels. Do not use a T-connector or demand-flow regulator with diffusion sampling.

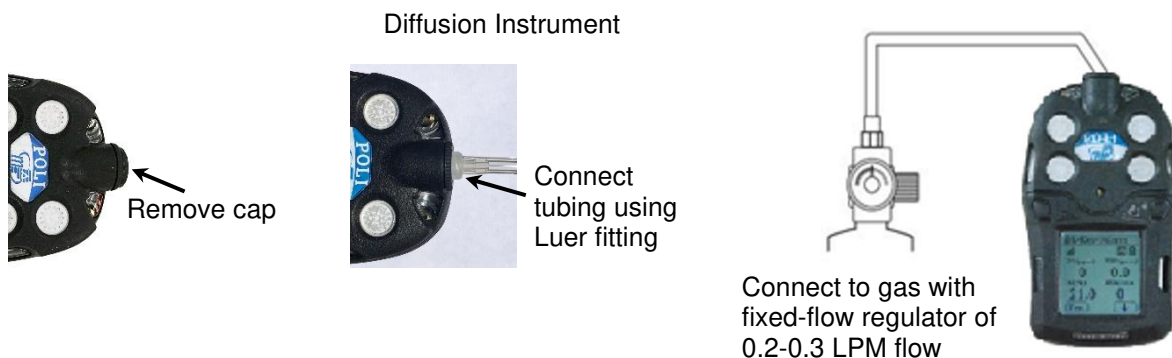

5.4.1.4 PTFE Connecting Tubing for Reactive Gases

For reactive gases including ozone, chlorine, chlorine dioxide, hydrochloric acid, hydrofluoric acid, and absorbable gases such as most VOCs, it is critical to use inert connecting tubing such as PTFE (Teflon) and make connections as short as practical. More flexible variants such as PTFE-lined Norprene or PTFE-lined Tygon are suitable alternatives. For most other gases, including standard 4-gas mixes with carbon monoxide, hydrogen sulfide and methane, Tygon tubing is adequate and convenient because of its flexibility.

5.4.1.5 Other Attachments

It is always most accurate to calibrate the POLI with all attachments in place in the same manner as in the field measurements. For example, normally a filter should be used on the POLI inlet for both measurements and calibration. However, if a filter is not used during measurement (as preferred in a few cases of highly reactive gases) then no filter should be used during calibration. Similarly, if extension tubing is being used during sampling, a more accurate calibration is obtained if the tubing is also attached during calibration. This method accounts for any small changes made to the gas concentration by the attachment(s).

5.4.2 Fresh Air (Zero) Calibration

Air calibration should precede span calibration and be done in clean air with 20.9% oxygen (and 400 ppm CO₂, if this sensor is installed). This procedure determines the zero points of most sensors and the span calibration for the oxygen sensor. No gas connections are required if the ambient air contains no detectable contaminants. Fresh Air calibration sets the oxygen sensor reading to 20.9% and the carbon dioxide sensor reading to 400 ppm. To calibrate these sensors to 0 readings use the Single Zero menu below.

In Configuration Mode, enter the Calibration menu and select 'Fresh Air Calib' to show the selected sensor list. De-select any sensor(s) not wanted to be zeroed ([↕/↕] (Change)). Start the zero calibration by pressing [+ / OK] '✓' to initiate the 30-second zero calibration count-down.

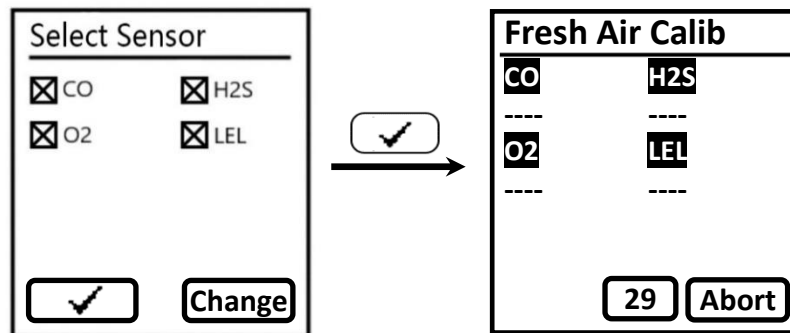

The zeroing process can be aborted at any time during this count-down by pressing [↕/↕]. When the zero calibration is complete, the 'Pass' or 'Fail' result is shown for each sensor.

5.4.3 Single Zero Calibration (O₂ and CO₂ Sensors)

Single Zero calibration is used to set the baseline for the oxygen and carbon dioxide sensors. This calibration is needed mostly for applications in rather low oxygen concentrations below about 5 Vol%, because the oxygen baseline is usually quite stable. It is not normally needed for breathing air applications near 20.9 Vol% oxygen.

To perform an oxygen or carbon dioxide zero calibration, enter the 'Single Zero' menu, select the O₂ or CO₂ sensor, apply zero gas (e.g., nitrogen) to the POLI inlet, and proceed as described for Fresh Air Calibration above. The nitrogen count-down time is 60 seconds for O₂ and 90 seconds for CO₂. Other inert gases such as argon or helium could also be used as long as they are free of the target gas.

5.4.4 Span Calibration

In Configuration Mode, enter the Calibration menu and select 'Span Calib'. Depending on the configuration of the POLI, multiple sensors may be calibrated simultaneously. Select the desired sensors and press [+ / OK] '✓'. Verify that the span gas concentrations match those of the gas cylinder. If not, abort and go to the Span Value menu to adjust. If OK, turn on the gas flow, connect the gas to the POLI, and press Start to initiate the 60-second count-down. The When complete, the display shows the sensor readings alternately with a 'Pass' or 'Fail' message. The span calibration can be aborted at any time during the count-down by pressing [↕/↕] (Abort).

NOTE: If the sensor calibration fails, try again. If calibration fails again, turn off the power and replace the sensor. **WARNING!** Do not replace sensors in hazardous locations!

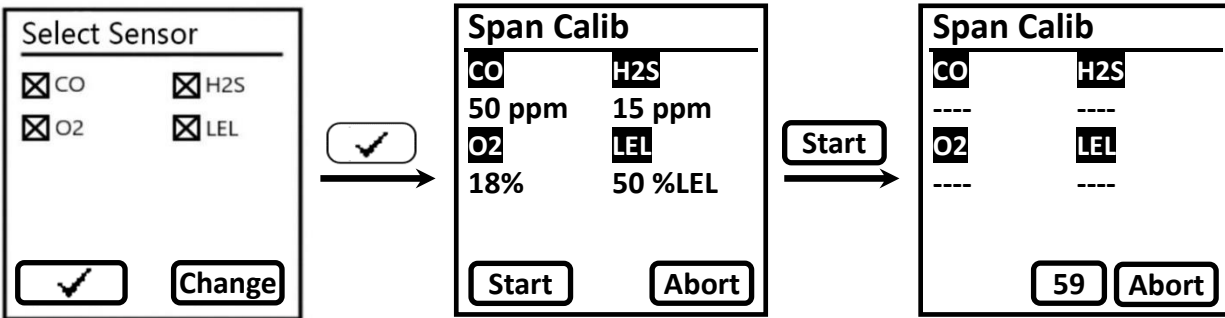

Gases that are not available as mixtures must be calibrated individually by de-selecting all other sensors. When calibrating sensors for cross-reactive gases such as chlorine and ammonia or chlorine dioxide and hydrogen sulfide, be sure to allow a few minutes between calibrations for the previous gas to clear and toxic gas sensor readings to return to zero.

5.4.5 Bump Test

Enter the Calibration menu and select 'Bump Calib'. Most commonly the same gas is used for bump testing as for a full calibration. Perform the bump test in the same manner as for Span Calibration, ensuring that the test gas concentration values match those of the gas supply cylinder. The Bump Test lasts 30 seconds, or as long as it takes to pass, whichever is shorter. It can be aborted at any time during the 30 seconds. When the bump test is complete, the 'Pass' or 'Fail' result is shown for each sensor. Be sure to calibrate any sensor that fails a bump test.

Important! Make sure all of the sensors have warmed up before performing the bump test. The instrument will display three dashes ('--') next to the sensor name during warm up. Once a sensor has warmed up it will show a concentration reading and a bump test can proceed.

5.4.6 Set Span Value

To change the calibration gas concentrations, enter the Calibration menu and select 'Span Value'. Update the values as needed and press Done to exit and acknowledge any changes when asked to 'Save?'. To switch the Left soft key function from increasing to decreasing, hold both keys down simultaneously for about 2 seconds until **Inc/+** changes to **Dec/-**.

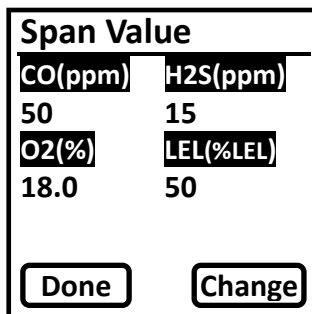

5.5 Measurement

Use this menu to enable or disable sensors and to set gas concentration units. Note that the Measurement Gas type for PID and LEL sensors can only be selected using mPower Suite.

5.5.1 Enable/Disable Sensor

Sensors can be disabled if they are not needed for a particular application, or if a sensor fails but the other sensors still provide useful readings. In Config Mode, enter the Measurement menu and select 'Enable/Disable'. Press 'Change' and select or de-select sensors as needed. Then scroll to and press on the '✓' box. Acknowledge 'Save' for any changes made, or press X to discard.

5.5.2 PID Measurement Gas

Enter the 'PID Meas. Gas' menu to view a list of chemicals with stored correction factors (CFs) for the 10.6 eV lamp. Scroll down the list using the [✓/↓] key. For fast scrolling, hold the [✓/↓] key down to skip by alphabetic first letter groups. To change scrolling directions, press both keys simultaneously for about 2 seconds. When the desired gas is found, press '✓' to select and '✓' again to save and exit. The Measurement Gas can also be set in mPower Suite (see Section 6).

5.5.3 Set User CF

In this menu the user can define up to 15 Custom Gas PID correction factors for compounds not in the pre-existing gas library. Scroll down and select the desired Custom Gas number, and press [Inc/+] to increase the CF. To change to [Dec/-], press both keys simultaneously for about 2 seconds. When the desired value is entered, press 'Done' to accept and '✓' to save and exit. A Custom Gas name can be entered using mPower Suite (see Section 6). Custom CFs for LEL measurements can only be entered using mPower Suite (Section 6).

5.5.4 Gas Unit

From the Measurement menu select 'Gas Unit' and press 'Change' to alter the concentration unit for any sensor. Then scroll to and press 'Done' and 'Save' to save changes. Options include:

Gas Unit Options

- ppm (parts per million)
- mg/m³ (mg per cubic meter)
- μmol/mol (micromole per mole)
- 10⁻⁶ (1 millionth mole fraction)
- % (Volume %)
- % LEL (% of Lower Explosive Limit)

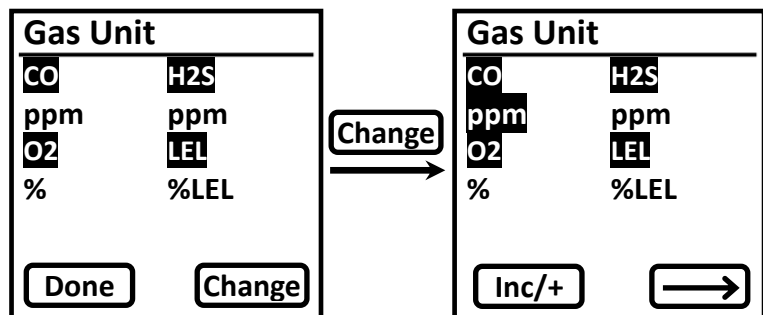

The units ppm, μmol/mol (micromole per mole) and 10⁻⁶ are essentially the same unit expressed with a different label. Conversion from ppm to mg/m³ is done automatically using the gas molecular weight stored in the firmware. Units for sensors reading in % Vol or %LEL cannot be changed.

CAUTION! Be sure that the Gas Concentration Unit of the instrument matches that on the Calibration Gas cylinder used for each sensor. Otherwise, dangerously low readings could result. Once calibration is complete, the units can be changed between the first four on the list above and the readings will be correct. Then make sure that alarm limits are entered in the same units that are selected for the concentration readout.

5.6 Alarm Settings

Use this menu to change alarm limits, select alarm devices, enable a heartbeat light and enter Man-down alarm parameters.

5.6.1 High, Low, STEL and TWA Alarm Limits

In the 'Alarm Setting' menu, select the desired alarm type and enter the values for each sensor as described above in Section 5.3.3. Make sure that the concentration units of the alarm limits match those selected for the displayed concentration readings. **Note:** Some alarm limits are not applicable to all sensors. For example, the oxygen and LEL sensors do not appear in the list of STEL and TWA alarm limits.

5.6.2 Alarm Device

Use this menu to select or de-select any combination of the audio (buzzer), visual (LED) or vibration alarms.

⚠ WARNING!

Disabling all of the alarm devices prevents notification of hazardous gas concentrations and can lead to serious injury or death!

5.6.3 Heart Beat Light

The 'Heartbeat' light flashes an LED at regular intervals to verify that the unit is still on. This is especially useful in high noise situations where the pump cannot be heard. The interval between flashing lights can be set between 1 and 10 seconds, or turned off by setting to 0.

5.6.4 Man-Down Function

The POLI includes a Man-Down Alarm as a critical and potentially lifesaving safety feature for all models. When a user who is carrying the instrument stops moving or shifts to an abnormal position for a set period of time, the Man-Down Alarm is triggered, notifying anyone within earshot that the user may need rescue. The user is pre-warned by visual and audio alarms at 1 pulse per second that the Man-Down condition has been detected. He then has a set time to clear the warning by pressing '✓' if he is OK. If not cleared in time, a louder Man-Down Alarm starts, consisting of a short vibration followed by a pitch-rising, once-per-second alarm to warn nearby co-workers. During the warning period the user can also press 'X' if he is in distress, to start the full Man-Down Alarm immediately. These alarms are very different from high-gas alarms, so that co-workers can easily distinguish them. If a full Man-Down Alarm starts but the user is OK, it can be stopped using the Left key (Clear).

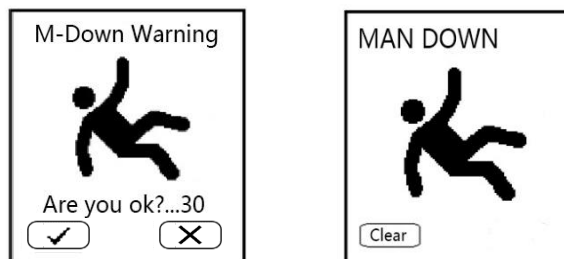

Future versions of the POLI will allow connection to a wireless network for transmission of various alarms, including Man-Down, to team-mates, supervisors or safety officers on site or at remote locations for timely rescues.

⚠ WARNING!

The Man-Down feature cannot detect a worker in distress in all situations even if they have collapsed. The Man-Down function should not be used to supplant other safety precautions.

5.6.4.1 Man-Down On/Off

The Man-Down On/Off function has 4 settings:

- **Off**
- **On** Alarm is triggered with insufficient movement in any direction. The pre-warn or alarm can be cleared by quickly tilting, or by pressing the Left [+ /OK] key.
- **Vertical Off** The alarm stays off as long as the instrument is held in a vertical position, such as clipped to a belt (or straight upside-down), and triggers when in any other position including held sideways or laying face up or down. A pre-warn can be cleared by quickly returning the POLI to a vertical position, or pressing the Left [+ /OK] key.
- **Horizontal Off** The alarm stays off as long as the instrument is held in a horizontal position, such as laying face up on a table, and triggers when in any other position. A pre-warn can be cleared by quickly returning the POLI to a horizontal position, or pressing the Left [+ /OK] key.

The Man-Down icon on the main screen verifies that the Man-Down function is enabled.

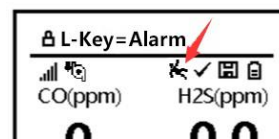

5.6.4.2 Man-Down Warn Time

This menu allows adjustment of the time allowed for the user to clear a pre-warn signal before the unit goes into full Man-Down Alarm. The pre-warn time can be adjusted between 10 and 60 seconds and the default value is 30 seconds.

5.6.4.3 Man-Down Threshold (Sensitivity)

This menu allows adjustment of the sensitivity to motion (On Mode) or position changes (Vertical or Horizontal Off Modes) for detecting a Man-Down condition. Low sensitivity means fewer alarms and High sensitivity means a greater likelihood of triggering an alarm.

5.6.4.4 Man-Down Motionless Time

This menu allows adjustment of the time allowed for stopped motion (On Mode) or position changes (Vertical or Horizontal Off Modes), before a Man-Down condition is detected. The motionless or position-change time can be adjusted between 10 and 60 seconds and the default value is 30 seconds.

5.7 Datalog

The instrument displays a floppy disk icon on the main screen to indicate that gas readings are being recorded in datalog. The instrument stores the measured gas concentration for each sensor along with date and time for each measurement. The POLI has enough memory to record six months' worth of data for four sensors at one-minute intervals. All data are retained (even after the unit is turned off) in non-volatile memory so that they can be downloaded at a later time to a PC using mPower Suite software (see Section 6). Datalogging cannot be turned off. When datalogging is full, it begins to overwrite the oldest data, which are permanently lost.

5.7.1 Clear All Data

This menu erases all data in the Datalog. **CAUTION!:** Cleared Datalog cannot be recovered.

5.7.2 Datalog Interval

The default interval is 60 seconds, and can be changed in a range of 1 to 3,600 seconds.

5.7.3 Datalog Sensor Selection

This menu allows selection of which sensors are included in the datalog. The entire list of installed sensors is shown, and they can be individually selected or de-selected.

Note: Turning a sensor off in Datalog does not affect its concentration readout, alarm settings, or any other settings.

5.8 Monitor Set-up

In this menu the user can set up various other functions including display contrast, backlight, and language, pump speed and stall threshold, date and time, and temperature unit.

5.8.1 LCD Contrast

The display contrast can be adjusted from values of 20 to 100. Normally the default setting does not need to be changed except in extreme ambient conditions of temperature and/or light.

5.8.2 Pump Speed

If the POLI is equipped with a pump, it can be set to low or high flow, or turned off to save battery and sample by diffusion. Low flow typically runs between 140 and 300 cc/min while high flow typically runs between 230 and 400 cc/min, both with a new pump and clean 0.45 μm filter in place. Running at low speed is quieter, extends pump lifespan, and conserves a small amount of power. Operating in diffusion mode with the pump off gives somewhat longer response times than with the pump on. There is almost no difference in sampling accuracy, except that a high pump speed gives faster and more accurate response when an extended length of sampling tubing is attached to the inlet.

5.8.3 Pump Stall

The Pump Stall setting defines the current draw threshold the detects a blocked pump. During normal operation if the gas inlet becomes plugged, the pump automatically turns off to avoid further damage. To adjust the stall threshold, enter the Pump Stall menu and press 'Change'. When prompted, block the inlet with a finger for 5 seconds and let go. During the blockage the pump should nearly stall and the current (I) reading should increase to a high value. The Threshold will adjust itself automatically. If the new Threshold seems unsatisfactory for some reason, press 'Clear' and repeat the 5-second blockage. When satisfied, press 'Done' followed by 'Save' to accept the new Pump Stall Threshold.

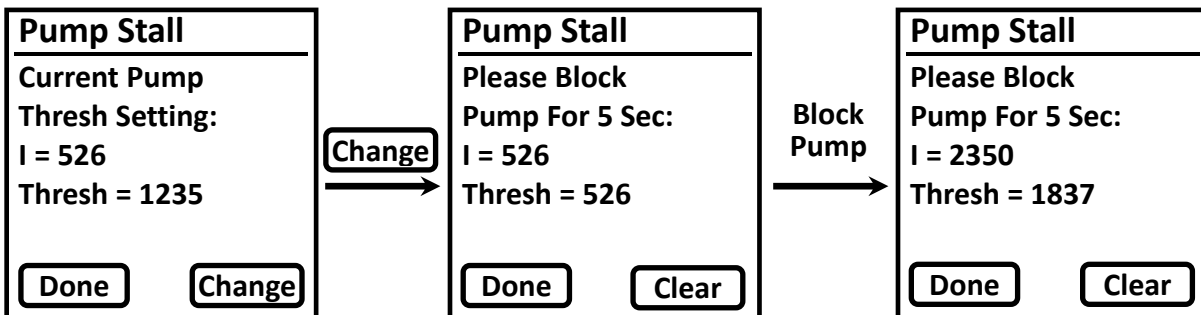

NOTE: A different Pump Stall Threshold must be set for each pump speed. The instrument remembers the corresponding thresholds so that the user does not need to re-set the threshold each time the pump speed is changed.

NOTE: The current (I) value depends on the Pump Speed, the condition of the inlet filter, and the firmware version. If the I readings do not change significantly when the inlet is blocked, some maintenance should be done such as replacing the filter, checking the gas flow path for obstructions or servicing the pump.

5.8.4 Temperature Unit

The POLI is equipped with an internal thermometer whose display units can be chosen in either Fahrenheit (°F) or Celsius (°C). The temperature readout can be viewed by scrolling through the Main User Menu (Section 4.6).

5.8.5 Language

Language options English, Traditional Chinese and Simplified Chinese are available. Spanish and other options will be added in new firmware versions.

5.8.6 Backlight Mode

The LCD backlight can be set to illuminate automatically (in low ambient light conditions), illuminate manually, or shut off. In Manual Backlight Mode the backlight can be turned on by pressing either key. Using the Left [↙/↓] key is convenient because it does not scroll to another display (but does test the alarms). The backlight turns off automatically after 10 seconds if no key is pressed.

5.8.7 LCD Auto Flip

The LCD can be configured to flip automatically when the POLI is positioned upside-down. The auto-flip feature can be turned off.



5.8.8 Policy Check

Here the instrument can be locked from use if the Cal or Bump test interval has passed.

- “Must Bump/Cal” locks the instrument once the Bump or Cal interval is reached, until a Bump or Cal is performed.
- “Bump/Cal Due (Lock)” allows overriding the Bump/Cal requirement by entering the instrument password.

5.8.9 Clock Set-up

The Clock Set-up menu is used to adjust the date and time as for any numerical inputs (see Section 5.3.3). The date is in Month-Day-Year format and the clock is in 12-hour format. The clock can also be set to synchronize with the PC, if that option is enabled using mPower Suite.

5.9 Wireless Set-up (mSquad and mPlatoon)

Wireless remote communication is operative in the MP400S and MP400H POLI models. It is not included with MP400 or MP400P models. An MP400H can communicate with 7 MP400S units up to 0.5 miles (0.8 km) away, forming an mSquad of up to 8. Multiple (up to 8) mSquads can be connected to form an mPlatoon using the mLink-F modem, which communicates up to 2 miles (3 km) with each MP400H. The mLink is controlled using the mPower Suite mobile App on a smartphone or tablet via Bluetooth within 32 ft (10 m). If an alarm occurs in any one unit, all units within an mSquad also go into alarm for a short period (about 1 minute) and then stop, but the alarm continues on the affected unit and the MP400H until the alarm condition is cleared. If an mLink is used, the alarm is also transmitted to the command center and displayed on the mobile phone or tablet.

For comprehensive information on Wireless Systems' operation see the mSquad MP400S and MP400H User's Guide. For details on controller operations see the mPower Suite Mobile App User's Guide (as of 2020 available on Android devices only).

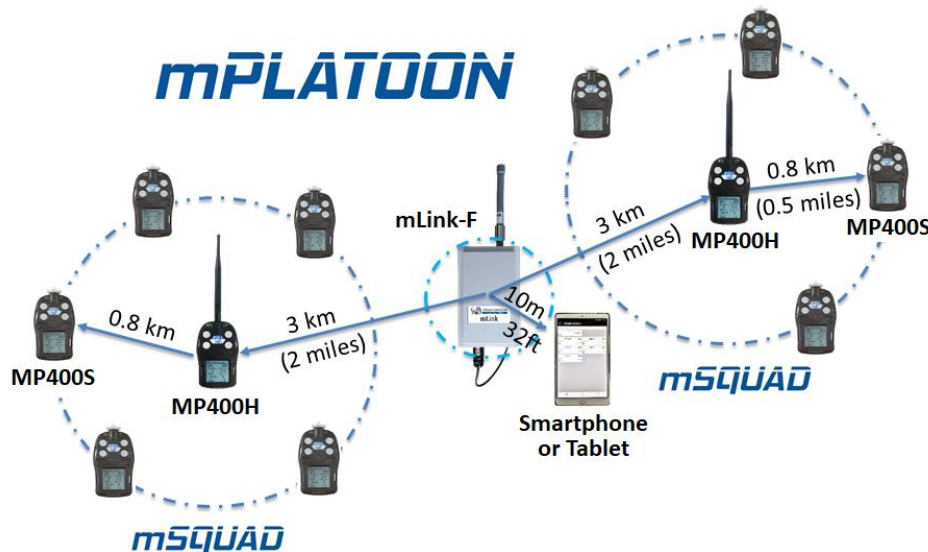

5.9.1 Register

Registering connects communication between the current instrument and the host module (only operative in MP400H and MP400S)

5.9.2 Host Module ID

The ID of the Host Module is displayed here (only operative in MP400H and MP400S).

5.9.3 Channel

One of 16 communication channels can be selected (only operative in MP400H and MP400S).

6. Data Communication

The mPower Suite software can be used to 1) download logged data, 2) upload configuration parameters to the instrument, 3) display readings on a PC and download in real time and 4) upgrade the instrument firmware. mPower Suite and instrument firmware can be downloaded from our website at <https://www.mpowerinc.com/software-downloads/>.

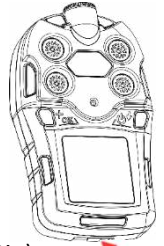

Micro B (5-Pin) to USB cable

6.1 Connecting and Configuring

- Turn on the instrument, cycle through the Main User Mode and enter PC Comm.
- Connect the USB cable to the PC and the Micro-USB end to the instrument.*
⚠**WARNING!** Connect only in non-hazardous environments!
- Start mPower Suite on the PC and click the “Search” button to find the instrument.
- Find the instrument in the left bar Device Connected list. Click on the S/N to get the configuration file from the instrument.
- Edit the configuration parameters as desired including those under the tabs for each sensor in the upper right. Click “Write” to upload the configuration to the instrument.
- “Read” allows downloading the current configuration file from the instrument.
- “Save” allows storing the current configuration file to the PC.
- “Load” allows calling up a stored configuration file from the PC to mPower Suite.
- To update the instrument firmware, select “Firmware Upgrade”. The firmware must first be downloaded to the PC from the mPower website www.mPowerinc.com.

*NOTE: Any locally-obtained USB A to Micro B USB cable will work for battery charging, but will not work for communication with mPower Suite software. The mPower USB cable P/N M-011-3003-000 is required for a PC to recognize the instrument and communicate with mPower Suite.

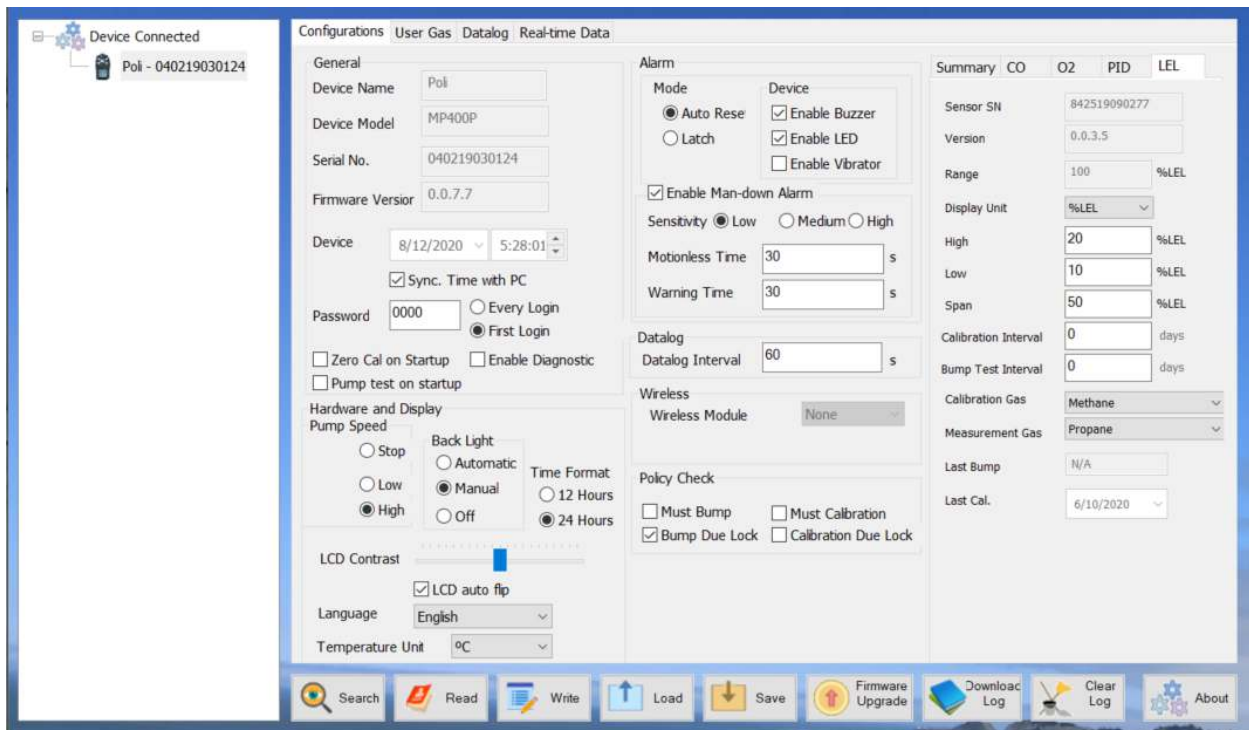

mPower Suite Main Configuration Screen

6.1.1 Configuration Details

These items can be set up using mPower Suite and are not accessible in the instrument Configuration Mode or are easier to manage in mPower Suite.

- **Bump and Calibration due** notifications can be set under the Summary tab in the far right panel. The software allows setting intervals between 1 and 365 days, but for all POLI instruments calibration intervals should not exceed 180 days. Notifications are disabled by setting the intervals to zero. In the middle panel, the “Policy Check” feature can lock the instrument from being used without Cal or Bump test.
 - “Must Bump/Cal” locks the instrument once the Bump or Cal interval is reached, until a Bump or Cal is performed.
 - “Bump/Cal Due Lock” allows overriding the Bump/Cal requirement by entering the instrument password.

NOTE: If the Policy Check panel is inactive (greyed out), click the “Apply to All Selected Sensors” in the far right panel to activate.

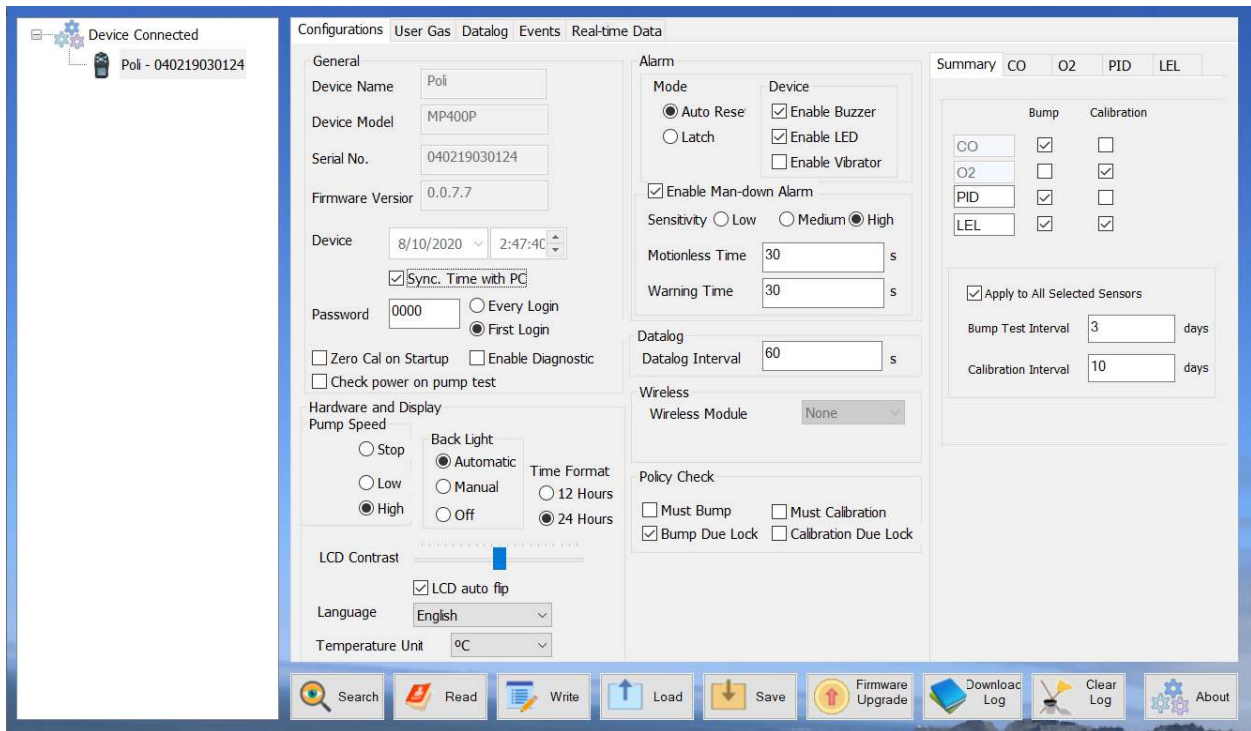

mPower Suite Bump/Cal Summary Configuration Screen

- **Calibration Gas** and a **Measurement Gas** can be selected from a list of a few hundred compounds for PID and Pellistor LEL sensors. If Measurement and Cal Gas are different, a correction factor is calculated and applied to make the sensor display in concentration equivalents of the measurement gas.
- **Setting Custom Gases** is done under the **User Gas** tab. Overwrite “Custom Gas 1” (User Gas 1) with the chemical name and press the ‘Return’ key. Enter the molecular weight (m.w.) and correction factors for a 10.6 eV PID lamp and for the LEL sensor. If either the PID or LEL sensor are not used or, leave the CF values as 0. The molecular weight is only needed when gas units of mg/m³ are used; if not, leave the m.w. at 0 or 1. By clicking the “Save User Gas” box on the right of the screen, the factors are sent to the instrument without sending any other configurations. The “Reset User Gas” button sets all values back to factory default on both the instrument and the mPower Suite panel.

Device Connected
Poli - 040219030124

Configurations User Gas Datalog Real-time Data

Gas Name	M.W.	CF (10.6...	CF (LEL)
Chloroacetone	95.52	1.2	1.7
Carcinogen X	68.7	0.83	1.4
Custom Gas 3	0	1	1
Custom Gas 4	0	1	1
Custom Gas 5	0	1	1
Custom Gas 6	0	1	1
Custom Gas 7	0	1	1
Custom Gas 8	0	1	1
Custom Gas 9	0	1	1
Custom Gas 10	0	1	1
Custom Gas 11	0	0	0
Custom Gas 12	0	0	0
Custom Gas 13	0	0	0
Custom Gas 14	0	0	0
Custom Gas 15	0	0	0

Save User Gas

Reset User Gas

Search Read Write Load Save Firmware Upgrade Get Log Clear Log About

mPower Suite User Gas Screen

6.2 Datalog and Event Retrieval

- To download the datalog from the instrument to the PC, select “Download Log”. This process can take several minutes because datalogging is always on and large files can be created. The datalog files will appear under the “Datalog” tab on the top of the screen. Below is a sample screen of datalog information listing sample time and instantaneous readings. A new Single Datalog file is created each time the instrument is turned on or the configuration is changed. The middle panel shows the file start time and number of data points.
- To export data to a csv file readable by Excel or other spreadsheet software, move the cursor over the right data panel and click the right mouse button, and then select either the current Single Datalog file or all the stored data (Whole Datalog).

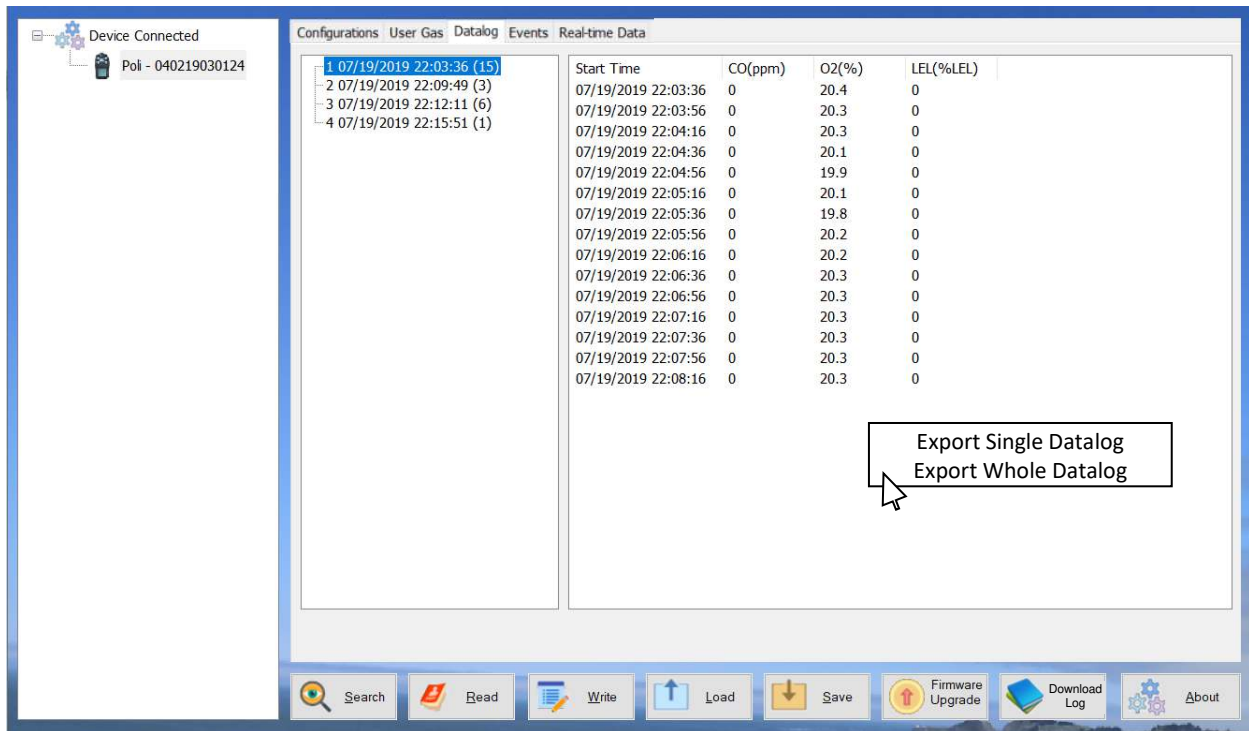

mPower Suite Datalog Screen

- Click on the Event tab for a list of alarm events, warnings and other information, selectable by the radio button on the right side of the panel. Information includes when the unit was powered on and off, low-battery shutdowns, changes in configuration such as alarm limits and span values, and installation of new sensors. Warnings include low battery, calibration date and time, and bump date and time, etc.
- Export the Event log by right-clicking on the right panel in a similar way as for exporting Datalog.

POLI User's Guide

Device Connected
Poli - 040219030124

Configurations User Gas Datalog Events Real-time Data

Serial No	Type	Event contents
236	Info	Power On at 07/21/2020 11:10:35
237	Info	Power Off at 07/21/2020 11:52:01 due to battery not low.
238	Info	Power On at 07/30/2020 15:13:37
239	Info	Power Off at 07/30/2020 15:14:49 due to battery not low.
240	Info	Power On at 07/30/2020 15:15:00
241	Info	Power On at 08/05/2020 15:29:03
242	Info	Power Off at 08/05/2020 15:37:20 due to battery not low.
243	Info	Cl2 sensor, sn: 840719070003, index 1#, added at 08/05/2020 17:07:09.
244	Info	LEL sensor, sn: 842519090277, index 3#, added at 08/05/2020 17:07:09.
245	Info	Power On at 08/05/2020 17:07:29
250	Info	CO sensor, index 0#, Span Value para changed from 60000 to 50000 at 08/05/2020 17:12:50.
252	Info	Power Off at 08/05/2020 17:28:50 due to battery not low.
253	Info	O2 sensor, sn: 840319030069, index 1#, added at 08/06/2020 17:04:30.
254	Info	Power On at 08/06/2020 17:04:49
255	Info	Power Off at 08/06/2020 17:08:47 due to battery not low.
256	Info	Power On at 08/06/2020 17:09:43
257	Info	Power Off at 08/06/2020 17:10:52 due to battery not low.
258	Info	Power On at 08/06/2020 17:34:27
259	Info	Power Off at 08/06/2020 17:38:19 due to battery not low.
260	Info	Power On at 08/07/2020 14:25:26
261	Info	Power On at 08/07/2020 17:19:11
262	Info	Power On at 08/07/2020 17:30:16
267	Info	Power Off at 08/07/2020 17:36:42 due to battery not low.
268	Info	Power On at 08/10/2020 13:54:56

All
 Alarm
 Information
 Warning

Search Read Write Load Save Firmware Upgrade Download Log Clear Log About

mPower Suite Event Information Log Screen

Device Connected
Poli - 040219030124

Configurations User Gas Datalog Events Real-time Data

Serial No	Type	Event contents
3	Warning	Battery low at 06/24/2020 16:25:21, battery voltage = 0.00 V, run time = 2:29:58.
4	Warning	Battery low at 06/24/2020 16:25:22, battery voltage = 0.00 V, run time = 2:29:59.
8	Warning	PID sensor, index 2#, calibrated at 06/26/2020 13:55:27, with 0 ppb gas, passed.
9	Warning	PID sensor, index 2#, calibrated at 06/26/2020 13:58:43, with 34464 ppb gas, passed.
9	Warning	Battery low at 07/10/2020 19:36:47, battery voltage = 0.00 V, run time = 7:08:49.
0	Warning	Battery low at 07/10/2020 19:36:48, battery voltage = 0.00 V, run time = 7:08:50.
1	Warning	Battery low at 07/10/2020 19:36:49, battery voltage = 0.00 V, run time = 7:08:51.
2	Warning	Battery low at 07/10/2020 19:36:50, battery voltage = 0.00 V, run time = 7:08:52.
3	Warning	Battery low at 07/10/2020 19:36:51, battery voltage = 0.00 V, run time = 7:08:53.
4	Warning	Battery low at 07/10/2020 19:36:52, battery voltage = 0.00 V, run time = 7:08:54.
5	Warning	Battery low at 07/10/2020 19:36:53, battery voltage = 0.00 V, run time = 7:08:55.
6	Warning	Battery low at 07/10/2020 19:36:54, battery voltage = 0.00 V, run time = 7:08:56.
7	Warning	Battery low at 07/10/2020 19:36:55, battery voltage = 0.00 V, run time = 7:08:57.
8	Warning	Battery low at 07/10/2020 19:36:56, battery voltage = 0.00 V, run time = 7:08:58.
9	Warning	Battery low at 07/10/2020 19:36:57, battery voltage = 0.00 V, run time = 7:08:59.
6	Warning	CO sensor, index 0#, calibrated at 08/05/2020 17:10:01, with 0 ppb gas, passed.
7	Warning	Cl2 sensor, index 1#, calibrated at 08/05/2020 17:10:02, with 0 ppb gas, passed.
8	Warning	PID sensor, index 2#, calibrated at 08/05/2020 17:10:02, with 0 ppb gas, passed.
9	Warning	LEL sensor, index 3#, calibrated at 08/05/2020 17:10:02, with 0 ppb gas, passed.
1	Warning	Cl2 sensor, index 1#, calibrated at 08/05/2020 17:14:57, with 10000 ppb gas, passed.
3	Warning	CO sensor, index 0#, calibrated at 08/07/2020 17:35:56, with 0 ppb gas, passed.
4	Warning	O2 sensor, index 1#, calibrated at 08/07/2020 17:35:56, with 5696 ppb gas, passed.
5	Warning	PID sensor, index 2#, calibrated at 08/07/2020 17:35:56, with 0 ppb gas, passed.
6	Warning	LEL sensor, index 3#, calibrated at 08/07/2020 17:35:57, with 0 ppb gas, passed.

All
 Alarm
 Information
 Warning

Search Read Write Load Save Firmware Upgrade Download Log Clear Log About

mPower Suite Event Warning Log Screen

6.3 Real-Time Data

- This function requires mPower Suite version 1.1.0.114 or later.
- To display a list of readings in real time, click on the “Real-time Data” tab on the top of the screen. Enter the desired reading time interval, select a folder on the PC for storing the data, and create a file name.
- Ensure that the POLI is connected and click “Start” to begin real-time monitoring. Select “Stop” when finished and “Clear” to discard the data when no longer needed.

The data should be available as an Excel-readable .csv file in the folder selected. To separate the data into columns in Excel, click on the “Data” menu on top and select “Text to Columns” to convert.

⚠ WARNING!

Safety certificates for hazardous locations are invalid when the POLI is operated with a cable connected to a computer or any other device. Perform real-time data transfers only in areas known to have no risk of explosion hazard.

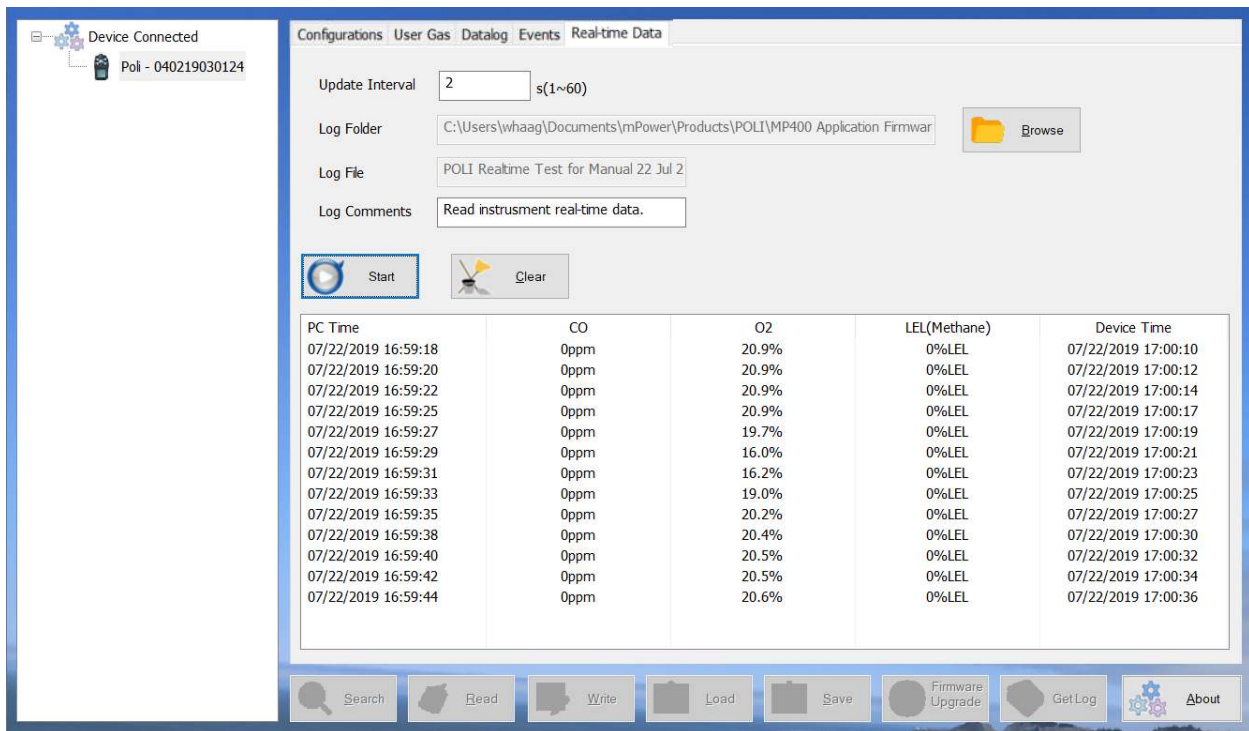

mPower Suite Real-time Data Screen

7. POLI MonoDock Operation

7.1 MonoDock Cal/Bump Procedures

- This function requires mPower Suite version 1.1.0.137 or later.
- The MonoDock comes in two versions, one for POLI Pumped monitors and one for POLI Diffusion monitors. Pumped versions preferably use a demand flow regulator to connect the gas, but a fixed-flow regulator of 0.5 LPM can be used. Diffusion versions can use either demand flow or fixed-flow regulators, in the latter case preferably with a flow of 0.3 LPM.
- Connect gas and regulator to the quick-connect in the Cal gas inlet port of the Docking Box using 6-mm or ¼-inch o.d. tubing. Connect the first gas to Gas Inlet 1 [9] and any second gas to Gas Inlet 2 [10].
- If the ambient air is not free of detectable compounds, connect the air inlet [8] to a fresh air source.



LED	Color	Description
Unit LED [4]	Green blinking	Cal/bump testing
	Green	Cal/bump test pass
	Orange	Sensor type mismatch
	Red	Cal/bump test fail
Status LED [3]	Green	Power On
	Green blinking	Low battery
	Orange	Charging



Docking Box Components

1. Micro USB
2. USB Port
3. STATUS LED
4. POLI LED
5. Cal button
6. Bump button
7. Monitor cradle
8. Air inlet
9. Cal gas inlet 1
10. Cal gas inlet 2
11. Microphone

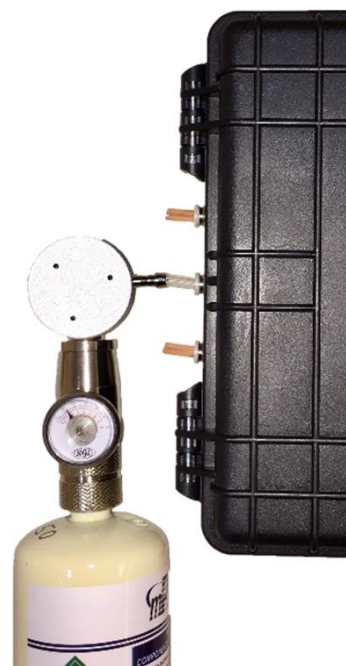

Calibration Gas Connections

- Place the instrument inlet side down into the cradle [7] and push down until it locks in place.
- Connect the Micro USB cable from the MonoDock to the POLI.
- If the Status LED [3] is off, press Cal/ [5] until the LED turns green.
- If a fixed-flow regulator is used, start the gas flow just before the next step, and turn it off

shortly after the Cal or Bump is complete.

- Push Cal [5] to initiate calibration or Bump [6] to run a bump test. The LED should blink green for about 3 min. during calibration or 1 min. during a bump test.
- If the calibration or bump is successful, the Unit LED [4] will be green, otherwise red.
- Up to 2000 Cal or Bump reports will be saved in the internal storage of the Docking Box.
- To power off, hold the Cal button until the status LED turns off.
- NOTE: The microphone is used to check the function of the audio alarm but does not require any user operation.

7.2 MonoDock Data Download and Calibration Certificates

- To download Cal/Bump log from the MonoDock to a PC, connect the two using a USB-to-USB cable inserted into the socket [2] on the MonoDock.
- Start mPower Suite on the PC and click the “Search” button to find the instrument.
- Click on “MonoDock” in the left bar Device Connected list. It is not necessary to have a POLI in the MonoDock.
- Select “Download Log”. The Cal/Bump files will appear under the “Datalog” tab on the top of the screen. Below is a sample screen showing a list of dates and times of the Cal/Bump events. Click on the event time to view the Cal/Bump results in the right panel.
- To export data to a csv file readable by Excel or other spreadsheet software, move the cursor over the right data panel and click the right mouse button, and then select either the current Cal/Bump result (Single Datalog) or all the stored results (Whole Datalog).
- To print a Calibration Certificate, right-click the mouse in the right panel and select Generate Certificate. Enter any desired information such as operator name and cylinder lot number, and click Print at the bottom.

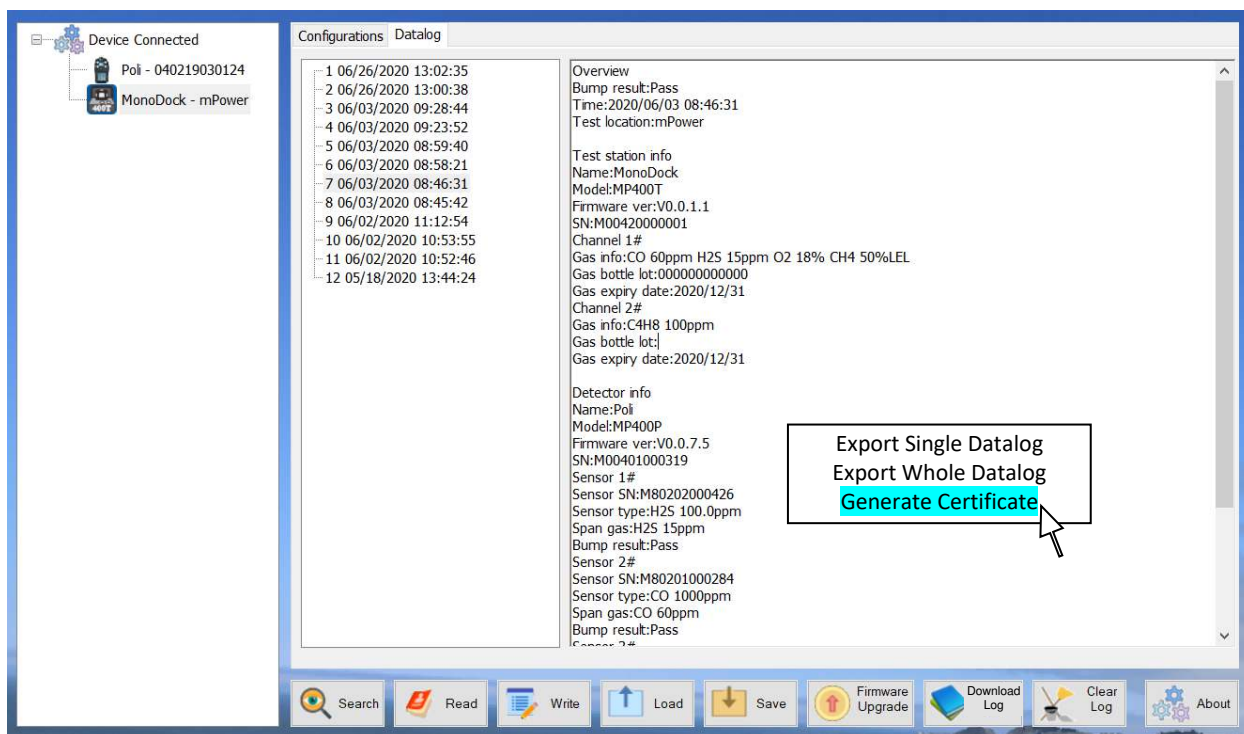

mPower Suite MonoDock Cal/Bump Log Screen

CERTIFICATE OF MONITOR CALIBRATION

DATE: 6/ 3/2020 ASSET ID #:

CALIBRATED BY: TITLE:

APPROVED BY: TITLE:

SIGNATURE (with date):

INSTRUMENT INFORMATION: Brand: mPower Electronics, Serial #: 040919080238, Model #: MP400P

CALIBRATION RESULT: PASS

Sensor Type	Gas	Concentration	Post Cal Reading	Sensor Serial # ^
H2S	H2S	15ppm	15.3ppm	840219080241
O2	O2	18%	17.9%	840319080172
LEL	CH4	50%LEL	49%LEL	842519080324
CO	CO	60ppm	62ppm	840119080420

Calibration Gas	Mix	Calibration Gas	Single	Monitor Kit Complete
Expiration Date	12/31/2020	Expiration Date	12/31/2020	
Lot # 1	000000000000	Lot # 2		Missing Parts
Manufacturer		Manufacturer		

Buttons: Print Certification, Cancel

POLI Calibration Certificate Generated using MonoDock

8. Maintenance

The POLI requires little maintenance, aside from daily battery charging (see Section 2), regular filter replacement, and sensor replacement as needed (1 to 3 years depending on sensor and use conditions). Under extreme conditions, the pump or battery may need service or replacement.

8.1 Replacing Filters

If the external filter is dirty or clogged, remove it by unscrewing it from the inlet. Discard it and replace it with a new water-trap filter. Dirty filters can be recognized by symptoms such as:

- Visible filter discoloration
- Frequent pump stalls
- A high pump current (I) value shown in the Pump Stall menu



We recommend filter replacement at least every month for instruments that are used regularly, and more frequently, possibly daily, when used under dusty or wet conditions.

IMPORTANT! A pumped POLI should not be calibrated or operated without a filter. Operation without a filter may damage the instrument. The only exception to this requirement is for use with reactive gases that may be partially lost on the filter.

8.2 Removing or Replacing Sensor Modules

⚠ WARNING!

Replace sensors only in non-hazardous locations.

All sensors are located inside the sensor compartment on the top side of the POLI circuit board assembly. They are accessed by removing the six screws in the back of the POLI and then turning the instrument over and lifting off the sensor cover.

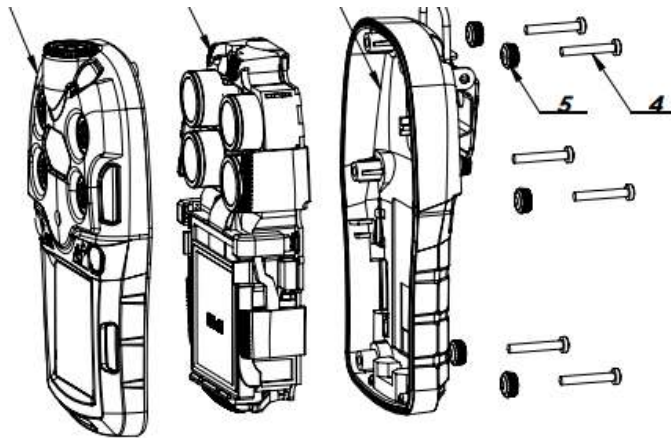

1. Turn off the instrument.
2. Remove the six screws in the back of the instrument.
3. Turn the instrument over, lift off the front cover.
4. Carefully lift out each sensor you wish to inspect or replace.
5. Install the replacement sensor. Make sure the electrical contact pins are aligned with the holes in the PC board and that the sensor is seated firmly. The location of a sensor does not matter except that high-power sensors have double winged housings and can only be placed in slots 1 and 2 with double-winged openings. Low-power sensors have single wings and can be inserted into any of the four sensor slots. The firmware automatically recognizes the sensor type at each location.
6. Replace the cover and tighten the 6 screws.

IMPORTANT! Always perform a full calibration after replacing sensors.

8.3 Cleaning or Changing PID Sensor Detector or Lamp

8.3.1 PID Lamp Cleaning Procedure

1. Pry off the PID sensor cover using a small flathead screwdriver.



2. Put on finger gloves and pull out lamp. Replace lamp or clean window as described below.
3. Use a cotton swab wetted with methanol to clean the flat window surface of the lamp. If greasy dirt is hard to remove using methanol, the window can be polished using fine alumina powder polishing paste.
4. Dry the lamp with clean tissue, re-insert into the PID sensor module and close the cover.



8.3.2 Sensor Detector Cleaning

1. Pry off the PID sensor cover and pull out the sensor detector.
2. Put the sensor detector into a beaker of pure methanol or ethanol.
3. Place the beaker into an ultrasonic cleaning bath (jewelry cleaner) and sonicate for 15 minutes. Remove the sensor and dry it thoroughly. If possible, use a gentle stream of clean air to blow the residual dust-containing liquid out of the sensor. Complete drying may take a few hours before reassembly to ensure a stable PID baseline.
4. Always re-calibrate the PID after cleaning the sensor.



8.4 Replacing Pump or Battery

For replacement of battery or pump, please contact an authorized mPower service center.





9. Troubleshooting

Problem	Possible Reasons & Solutions
Cannot turn on power after charging the battery	<p>Reasons: Defective USB cable or charging circuit. Defective battery.</p> <p>Solutions: Try charging the battery again. Replace USB cable or charger.</p>
Lost password	<p>Solutions: Call Technical Support at (408) 320-1266</p>
Buzzer, LED lights, and vibration motor inoperative	<p>Reasons: Buzzer and/or other alarms disabled. Bad buzzer.</p> <p>Solutions: Check under 'Alarm Settings' in Configuration Mode that buzzer and/or other alarms are not turned off. Call authorized service center.</p>
Pump failed message Pump alarm	<p>Reasons: Inlet probe blocked. Direct connection to calibration gas outlet before the regulator is opened. External filter plugged with dirt or liquid. Water condensed in the internal gas distribution lines. Bad pump or pump circuit.</p> <p>Solutions: Remove the blocking materials and then press [+ / OK] key to reset the pump alarm. Replace the contaminated external filter. Be careful not to allow water condensation inside the unit. Replace or rebuild the pump (by Service Center).</p>
Inlet gas flow weak	<p>Reasons: Flow path leaks. Pump diaphragm damaged or has debris.</p> <p>Solutions: Check flow path for leaks; such sensor module gasket, inlet tubing and filter connections. For pump diaphragm cleaning or pump replacement call mPower Service Center.</p>
“Lamp” alarm	<p>Reasons: Lamp drive circuit. Weak or defective PID lamp.</p> <p>Solutions: Turn unit off and back on. Replace lamp or whole PID sensor.</p>
Readings abnormally high or low or noisy.	<p>Reasons: Dirty or plugged filter or inlet. Dirty or old sensor. Excessive moisture and water condensation. Incorrect calibration.</p> <p>Solutions: Replace filter. Replace sensor or clean PID sensor. Blow-dry flow path and/or PID sensor module. Calibrate unit.</p>
Cannot communicate with PC	<p>Reason: Solution: Wrong cable. Use mPower USB cable P/N M-011-3003-000.</p>

For replacement parts please contact an authorized mPower Service Center.

10. Technical Specifications

Detector Specifications

Size	5.74 x 3.31 x 1.65 in (140 x 84 x 42 mm)
Weight	15.5 oz (435 g)
Sensors	Over 30 interchangeable and field-replaceable sensors including PID for VOCs, EC for Toxic and O ₂ , Pellistor for LEL, and NDIR for LEL, Vol% & CO ₂
Response Time (t90)	• 15 seconds (LEL/CO/H ₂ S/O ₂) • Others vary – see sensor specification sheet
Battery	Rechargeable Li-ion pack: 16 hours in diffusion mode, 12 hours with pump
Direct Readout	• Real-time reading of gas concentration • PID measurement gas and correction factor, • Visual compliance indicator • Battery status • Datalogging on/off • STEL, TWA, peak and minimum values • Man-Down alarm on/off
Display	128 x 128 graphical LCD, 1.77 x 1.73 in (45 x 44 mm), with LED backlight for enhanced readability. Automatic screen "flip" feature
Keypad	2 Operation keys
Sampling	Built-in pump or diffusion
Calibration	Manual calibration or automated using POLI Docking Box. CaliCase option allows automatic bump test and calibration on up to 4 units simultaneously
Alarms	• Audible (95 dB @ 30 cm) • Visual (flashing bright red LEDs) • Vibration • On-screen indication of alarm conditions • Man-Down alarm with pre-alarm • Panic Alarm (manual)
Datalogging	Continuous datalogging (6 months for 4 sensors at 1-minute intervals, 24 hours/day and 7 days/week)
Charging and Communication	Charging, data download, instrument setup and firmware upgrades on PC or laptop via PC comm, cradle, travel charger, or CaliCase.
Temperature	-4° to 122°F (-20° to 50°C)
Humidity	0% to 95% Relative humidity (non-condensing)
IP Rating	IP-65 (pump versions); IP-67 (diffusion versions)
Safety Certifications	 Class I, Div 1, Group ABCD T4, -20°C ≤ T _{amb} ≤ +50°C  Ex ia IIC T4 Ga  II 1G Ex ia IIC T4 Ga  European Conformity
EMC/RFI	EMC directive: 2014/30/EU
Warranty	• 2 Years on instruments • 2 Years on sensors for LEL, LEL/Vol, O ₂ , CO, CO ₂ , H ₂ S, SO ₂ , HCN, NO, NO ₂ , and PH ₃ • 1 Year on other sensors

Sensor Options

Sensor	Range	Resolution
PID	0-200 ppm 0-2000 ppm 0-10000 ppm	0.01 ppm 0.1 ppm 1 ppm
Oxygen (O ₂)	Lead Wool Lead-Free	0-30%Vol 0.1%Vol 0.1%Vol
Combustibles (LEL%)	0-100%LEL	1%LEL
Hydrocarbons (Vol%)	0-100%Vol	0.1%Vol
Dual-Range LEL%/Vol%	0-100%Vol	1%LEL
CO ₂ (Carbon Dioxide)	0-50000 ppm	100 ppm
CO (Carbon Monoxide)	0-1000 ppm	1 ppm
H ₂ S (Hydrogen Sulfide)	0-100 ppm 0-1000 ppm	0.1 ppm 1 ppm
CO + H ₂ S	CO H ₂ S	0-500 ppm 0.1 ppm 0-200 ppm 0.1 ppm
SO ₂ + H ₂ S	SO ₂ H ₂ S	0-20 ppm 0.1 ppm 0-100 ppm 0.1 ppm
NH ₃ (Ammonia)	0-100 ppm 0-500 ppm	1 ppm 1 ppm
Cl ₂ (Chlorine)	0-50 ppm	0.1 ppm
ClO ₂ (Chlorine Dioxide)	0-1 ppm	0.01 ppm
COCl ₂ (Phosgene)	0-1 ppm	0.01 ppm
H ₂ (Hydrogen)	0-1000 ppm	1 ppm
HCl (Hydrogen Chloride)	0-15 ppm	0.1 ppm
HF (Hydrogen Fluoride)	0-20 ppm	0.1 ppm
HCN (Hydrogen Cyanide)	0-100 ppm	0.1 ppm
NO (Nitric Oxide)	0-250 ppm	1 ppm
NO ₂ (Nitrogen Dioxide)	0-20 ppm	0.1 ppm
PH ₃ (Phosphine)	0-20 ppm 0-1000 ppm	0.01 ppm 1 ppm
SO ₂ (Sulfur Dioxide)	0-20 ppm 0-100 ppm	0.1 ppm 0.1 ppm
C ₂ H ₄ O (Acetaldehyde)	0-20 ppm	0.1 ppm
ETO (Ethylene Oxide)	0-100 ppm	0.1 ppm
CH ₃ SH (Methyl Mercaptan)	0-10 ppm	0.1 ppm
THT (Tetrahydrothiophene)	0-40 ppm	0.1 ppm

Android



iOS



Scan the 2-D barcode to find the POLI Training App on a mobile device App store. This simulates all the functions and alarms of an actual POLI monitor.

All specifications and listed sensors are subject to change without notice. Please check for updates at www.mpowerinc.com.

Recommended Gas Span Concentrations

Note: Use balance gas of air if available, otherwise use nitrogen balance gas

Sensor	Resolution-Range	Calibration Gas	
PID	1-10000 ppm	100 ppm Isobutylene 1000 ppm Isobutylene if 3-pt cal needed	
PID	0.1-2000 ppm	100 ppm Isobutylene	
PID	0.01-200 ppm	10 ppm Isobutylene	
LEL/O ₂ /CO/H ₂ S	50%LEL/18% O ₂ /60 ppm CO/15 ppm H ₂ S		
Oxygen (O ₂)	0.1-30% Vol	18 %Vol O ₂ and/or 100% N ₂ to set zero	
Pellistor or NDIR Combustibles (LEL%)	1-100%LEL	50 %LEL (2.5 %Vol Methane) or 25%LEL (0.35%Vol Pentane)	
NDIR LEL/VOL Dual Range Methane	1-100%LEL/1-100%VOL	50 %LEL (2.5 %Vol Methane) 100% Vol Methane if 3-pt cal needed	
NDIR Hydrocarbons CH ₄ (Vol%)	0.1-100% Vol	20 %Vol Methane 100% Vol Methane if 3-pt cal needed	
CO ₂ (Carbon Dioxide)	100-50000 ppm	5000 ppm (0.5 %Vol) Carbon Dioxide	
CO (Carbon Monoxide)	1-1000 ppm	100 ppm CO	
H ₂ S (Hydrogen Sulfide)	0.1-100 ppm	25 ppm H ₂ S (15 ppm H ₂ S if 4-Gas mix)	
H ₂ S (Hydrogen Sulfide)	1-1000 ppm	100 ppm	
CO + H ₂ S	CO	1-500 ppm	100 ppm (60 ppm CO if 4-Gas mix)
	H ₂ S	0.1-200 ppm	25 ppm (15 ppm H ₂ S if 4-Gas mix)
SO ₂ + H ₂ S	SO ₂	0.1-20 ppm	5 ppm
	H ₂ S	0.1-100 ppm	25 ppm
NH ₃ (Ammonia)	1-100 ppm	50 ppm	
NH ₃ (Ammonia)	1-500 ppm	50 ppm	
Cl ₂ (Chlorine)	0.1-50 ppm	10 ppm	
ClO ₂ (Chlorine Dioxide)	0.01-1 ppm	0.5 ppm (Requires ClO ₂ generator)	
COCl ₂ (Phosgene)	0.01-1 ppm	1.0 ppm Cl ₂ (Requires Cl ₂ generator) or 2 ppm Cl ₂ cylinder	
H ₂ (Hydrogen)	1-1000 ppm	700 ppm	
HCl (Hydrogen Chloride)	0.1-15 ppm	10 ppm	
HF (Hydrogen Fluoride)	0.1-10 ppm	10 ppm HCl (@ Measurement RH)	
HCN (Hydrogen Cyanide)	0.1-100 ppm	10 ppm	
NO (Nitric Oxide)	1-250 ppm	25 ppm	
NO ₂ (Nitrogen Dioxide)	0.1-20 ppm	5 ppm	
PH ₃ (Phosphine)	0.01-20 ppm	5 ppm	
PH ₃ (Phosphine)	1-1000 ppm	100 ppm PH ₃ or 500 ppm H ₂ S	
SO ₂ (Sulfur Dioxide)	0.1-20 ppm	5 ppm	
SO ₂ (Sulfur Dioxide)	0.1-100 ppm	5 ppm	
C ₂ H ₄ O (Acetaldehyde)	0.1-20 ppm	10 ppm Ethylene Oxide	
ETO (Ethylene Oxide)	0.1-100 ppm	10 ppm	
CH ₃ SH (Methyl Mercaptan)	0.1-10 ppm	5 ppm	
THT (Tetrahydrothiophene)	0.1-40 ppm	10 ppm or 20 mg/m ³	

Technical Support and mPower Contacts

mPower Electronics Inc.

3046 Scott Blvd. Santa Clara, CA 95054

Phone: (408) 320-1266

Fax: (669) 342-7077

info@mpowerinc.com

www.mpowerinc.com

