

**COBHAM**

# SAILOR 6300 MF/HF DSC 150W/150W FCC/250W/500W

User manual





# **SAILOR 6300 MF/HF DSC 150W/150W FCC/250W/500W**

## **User manual**

**Document number:** 98-131070-THR-H

**Release date:** September 3, 2021

## Disclaimer

Any responsibility or liability for loss or damage in connection with the use of this product and the accompanying documentation is disclaimed by Thrane & Thrane A/S. The information in this manual is provided for information purposes only, is subject to change without notice and may contain errors or inaccuracies. Manuals issued by Thrane & Thrane A/S are periodically revised and updated. Anyone relying on this information should acquire the most current version e.g. from [www.cobhamsatcom.com](http://www.cobhamsatcom.com), **Cobham SYNC Partner Portal**, or from the distributor. Thrane & Thrane A/S is not responsible for the content or accuracy of any translations or reproductions, in whole or in part, of this manual from any other source. In the event of any discrepancies, the English version shall be the governing text.

Thrane & Thrane A/S is trading as Cobham SATCOM.

## Copyright

© 2021 Thrane & Thrane A/S. All rights reserved. Printed in Denmark.

## Trademark Acknowledgments

- **SAILOR** is a registered trademark of Thrane & Thrane A/S.
- Other product and company names mentioned in this manual may be trademarks or trade names of their respective owners.

## GPL notification

The software included in this product contains copyrighted software that is licensed under the GPL/LGPL. The verbatim licenses can be found online at:

<http://www.gnu.org/licenses/old-licenses/gpl-2.0.html>

<http://www.gnu.org/licenses/old-licenses/lgpl-2.1.html>

For the parts of the software that fall under the GPL/LGPL licenses, you may obtain the complete corresponding source code from us for a period of three years after our last shipment of this product, which will be no earlier than December 31, 2027, by sending a money order or check for DKK 50 to:

SW Technology/GPL Compliance,  
Cobham SATCOM (Thrane & Thrane A/S),  
Lundtoftegaardsvej 93D  
2800 Lyngby  
DENMARK

Write "source for product SAILOR 6300 MF/HF DSC" in the memo line of your payment. This offer is valid to anyone in receipt of this information.

<https://www.cobhamsatcom.com/legal/free-and-open-source-software-foss/>

This offer is valid to anyone in receipt of this information.

## **Warranties**

Any attempt to install or execute software not supplied by Thrane & Thrane on this device will result in the warranty being void. Any attempt to modify the software on this device in a way not specified by Thrane & Thrane will result in the warranty being void.

## Safety summary

The following general safety precautions must be observed during all phases of operation, service and repair of this equipment. Failure to comply with these precautions or with specific warnings elsewhere in this manual violates safety standards of design, manufacture and intended use of the equipment. Thrane & Thrane assumes no liability for the customer's failure to comply with these requirements.

### **GROUND THE EQUIPMENT**

To minimize shock hazard, the equipment chassis and cabinet must be connected to an electrical ground and the cable instructions must be followed.

### **DO NOT OPERATE IN AN EXPLOSIVE ATMOSPHERE**

Do not operate the equipment in the presence of flammable gases or fumes. Operation of any electrical equipment in such an environment constitutes a definite safety hazard.

### **KEEP AWAY FROM LIVE CIRCUITS**

Operating personnel must not remove equipment covers. Component replacement and internal adjustment must be made by qualified maintenance personnel. Do not service the unit with the power cable connected. Always disconnect and discharge circuits before touching them.

### **Service**

General service must be done by skilled service personnel.



**Caution!** Electric shock hazard. Do not open the equipment. Only skilled service personnel may service and repair the equipment.

## RF exposure hazards and instructions

Your Thrane & Thrane radio generates electromagnetic RF (radio frequency) energy when transmitting. To ensure that you and those around you are not exposed to excessive amounts of energy and thus to avoid health hazards from excessive exposure to RF energy, all persons must obey the following:



**Caution!** Never touch the Antenna Tuning Unit or feeder wire when the MF/HF radio is transmitting. High voltage which can cause death or serious injury is present at the locations shown in the illustration below.

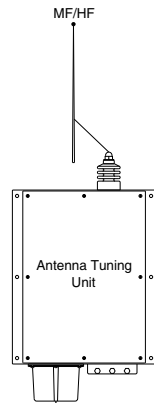

## Warranty limitation

The radio is not a user maintainable unit, and under no circumstances should the unit be opened except by authorized personnel. Unauthorized opening of the unit will invalidate the warranty.

## Emergency calls



**Lift Cover**

**Press RED Button**

until beep sounds continuously  
(more than 3 seconds)

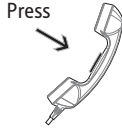

Use the **HANDESET** for voice calling

<p><b>MAYDAY-MAYDAY-MAYDAY</b> This is <b>NAME-NAME-NAME</b>  <b>CALLSIGN</b> or other IDENTIFICATION  <b>MMSI</b> (If the initial alert is sent by DSC)</p>	<p><b>OWN ID</b></p>	<p>SHIP's NAME: _ _ _ _ _</p>
		<p>CALLSIGN: _ _ _ _ _</p>
		<p>MMSI: _ _ _ _ _</p>

**MAYDAY**

**NAME** of the **VESSEL** in distress  
**CALLSIGN** or other **IDENTIFICATION**  
**MMSI**  
(If the initial alert is sent by DSC)

**POSITION**  
given as **latitude** and **longitude**  
or  
If latitude and longitude are not known  
or if time is insufficient,  
in relation to a known geographical location

**NATURE** of distress  
Kind of **ASSISTANCE** required  
Any other useful **INFORMATION**

	DSC	Radlotelephony	NBDP
VHF	Channel 70	Channel 16	---
MF	2187.5 kHz	2182.0 kHz	2174.5 kHz
HF4	4207.5 kHz	4125.0 kHz	4177.5 kHz
HF6	6312.0 kHz	6215.0 kHz	6268.0 kHz
HF8	8414.5 kHz	8291.0 kHz	8376.5 kHz
HF12	12577.0 kHz	12290.0 kHz	12520.0 kHz
HF16	16804.5 kHz	16420.0 kHz	16695.0 kHz

Remember to use the correct HF-procedures  
Don't forget your EPIRB is the secondary means of alerting

99-132140



# Preface

## Radio for occupational use

SAILOR 6300 MF/HF DSC obeys the requirements of SOLAS and is intended for use in maritime environment.

SAILOR 6300 MF/HF DSC is designed for *occupational use only* and must be operated by licensed personnel only.

SAILOR 6300 MF/HF DSC is not intended for use in an uncontrolled environment by general public.

## Manual overview

This manual has the following chapters:

- *Introduction* contains a description of the MF/HF radio and its components.
- *Operation* explains how to start up the radio, make and receive voice, Distress and DSC calls, including how to handle multiple sessions, Watch and Replay.
- *Service & maintenance* contains support information including a weekly check, diagnostics and a troubleshooting guide.

# Training information (for FCC approved equipment)

The TT-6300 MF/HF DSC is designed for occupational use only and is also classified as such. It must be operated by licensed personnel only. It must only be used in the course of employment by individuals aware of both the hazards as well as the way to minimize those hazards.

The radio is thus NOT intended for use in an uncontrolled environment by general public. The SAILOR 6300 MF/HF DSC has been tested and complies with the FCC RF exposure limits for Occupational Use Only. The radio also complies with the following guidelines and standards regarding RF energy and electromagnetic energy levels including the recommended levels for human exposure:

- FCC OET Bulletin 65 Supplement C, evaluating compliance with FCC guidelines for human exposure to radio frequency electromagnetic fields.
- American National Standards Institute (C95.1) IEEE standard for safety levels with respect to human exposure to radio frequency electromagnetic fields, 3 kHz to 300 GHz
- American National Standards Institute (C95.3) IEEE recommended practice for the measurement of potentially hazardous electromagnetic fields - RF and microwaves.

Below the RF exposure hazards and instructions in safe operation of the radio within the FCC RF exposure limits established for it are described.

## Warning

The radio set generates electromagnetic RF (radio frequency) energy when transmitting. To ensure that no personnel will be exposed to excessive amounts of RF-energy and to avoid health hazards from excessive exposure to RF energy, the following safety distances must be followed:

Antenna	Safety distance
150W	Calculated: 1.71 m or 5.7 feet
250W	Calculated: 2.21 m or 7.3 feet
500W	Calculated: 3.12 m or 10.3 feet

Calculations cover a whip antenna with a maximum gain of 3dBi, worst case frequency (30 MHz), full power and 100% duty cycle (transmitter always on) considering the most conservative limits mentioned in:

- FCC OET Bulletin 65 (1997)
- Canada RSS102 (2010)
- Canada Safety Code 6 (2015)

## **Installation Example for 150W**

1. A whip antenna with a maximum gain of 3 dBi must be mounted at least 12.3 ft. (3.71m) above the highest deck where people may be staying during continuous radio transmissions. The distance is to be measured vertically from the lowest point of the antenna. This provides the minimum separation distance which is in compliance with RF exposure requirements and is based on the MPE radius of 5.7 feet (1.71 m) plus the 6.6 ft. (2.0 m) height of an adult.
2. On vessels that cannot obey requirements in item 1, the antenna must be mounted so that the lowest point of the antenna is at least 5.7 feet (1.71m) vertically above the heads of people on deck and all persons must be outside the 5.7 feet MPE radius during radio transmission.
  - Always mount the antenna at least 5.7 feet from possible human access.
  - Never touch the antenna when transmitting.
  - Use only authorized T&T accessories.
  - Only allow trained and certified operators knowing about RF-energy and hazards to operate the radio.
3. If the antenna has to be placed in public areas or near people with no awareness of the radio transmission, the antenna must be placed at an even greater distance. Consult the appropriate standard for exact limits, depending on national specifications.

Failure to observe any of these warnings may cause RF exposure exceeding above mentioned limits or create dangerous conditions.

## Related documents

Title and description	Document number
<b>SAILOR 630x MF/HF Control Unit,</b> Installation Guide	98-132396
<b>SAILOR 6300 MF/HF Transceiver Unit &amp; Antenna Tuning Unit 150/250/500 W,</b> Installation Guide	98-144542
<b>SAILOR 6000B MF/HF 150/250/500 W System,</b> Installation Manual	98-144591
<b>SAILOR 6000 MF/HF Radiotelex,</b> User Manual	98-151795
<b>SAILOR 6101 and SAILOR 6103 Multi Alarm Panel,</b> Installation and User Manual	98-130981
<b>Emergency call sheet</b>	98-132369

# Table of contents

---

## Chapter 1 Introduction

SAILOR 6300 MF/HF DSC .....	1
Accessories available .....	6
System configuration - example .....	8

## Chapter 2 Operation

Overview .....	9
General use and navigation .....	9
Basic MF/HF radio communication .....	17
Watch function .....	19
Scan .....	20
DSC calls .....	21
Phone book .....	38
Radiotelex .....	40
Replay function .....	41
Setup .....	42

## Chapter 3 Service & maintenance

Overview .....	53
Contact for support .....	53
Maintenance .....	53
Troubleshooting .....	56
Alerts in the Bridge Alert Management (BAM) system ...	58
Diagnostics .....	66

Table of contents

---

	Warranty and returning units for repair .....	70
<b>Glossary</b>	.....	73
<b>Index</b>	.....	75

# Introduction

## SAILOR 6300 MF/HF DSC

The SAILOR 6300 MF/HF DSC is a modular and flexible MF/HF radio that can be customized to your specific needs for MF/HF communication on work boats, high seas fishing vessels and merchant vessels



of all kinds. It offers simplex and semi-duplex SSB radiotelephony in the maritime mobile frequency bands from 150 kHz to 30 MHz. Services include voice transmissions, watch function, DSC operations (Distress calls, position info, Distress relay and more) and AM Broadcast reception.

The large display on the SAILOR 6301 Control Unit shows Rx and Tx frequencies and status, MMSI number, position information, system and channel properties, including indicators for transmission power and received signal strength. It is easy to read from almost all angles and the display light can be adapted to dark environments. Red text is shown on a black background providing good visibility in low light conditions while protecting night vision.

DSC operations are made using the four soft keys next to the display. The MF/HF radio can replay the last 240 s of received voice. This is a useful feature to minimize misunderstandings and to record audio when the radio is unattended. The SAILOR 6301 Control Unit has an Ethernet interface to connect to other equipment for control, monitoring and printing.

The SAILOR 6300 MF/HF DSC is available as a basic MF DSC radio that can be upgraded with an HF DSC option and/or a telex option. Telex operation requires a SAILOR 6018 Message Terminal.

## Features

- Rugged and reliable design.
- Full power range on all ITU channels: 1.6 — 30 MHz for 150 W, 250 W and 500 W systems (Reduced power in the frequency range 1.6 — 4.0 MHz for 500 W according to legislation).
- Powerful transceiver (150, 250 or 500 W).
- Outdoor automatic antenna tuning unit.
- Radiotelex using the SAILOR 6018 Message Terminal.
- Optionally 6 DSC Distress frequency watch keeping receiver.
- Intelligent scanning for Voice, DSC and radiotelex (optional).
- Ethernet with ThraneLINK.
- Compliant with GMDSS in sea areas A2, A3 and A4 (Wheelmark).
- Obeys DSC specification ITU493-14.
- Supports Bridge Alert Management (BAM)



## System overview

The MF/HF radio consists of a Control Unit with a handset, a Transceiver Unit and an automatic Antenna Tuning Unit. The MF/HF radio is available in the following power classes:

System sales item numbers 4063xxB-00500

System	Control Unit	Transceiver Unit	Antenna Tuning Unit
406310B-00500 TT-6310B	SAILOR 6301 Control Unit DSC Class A <sup>a</sup>	SAILOR 6365 MF/HF 150 W	SAILOR 6384 ATU
406311B-00500 TT-6311B		SAILOR 6366 MF/HF 150 W FCC	
406320B-00500 TT-6320B		SAILOR 6368 MF/HF 250 W	
406350B-00500 TT-6350B		SAILOR 6369 MF/HF 500 W	SAILOR 6383 ATU

- a. An additional SAILOR 6301 Control Unit can be added.

## Controls on the front

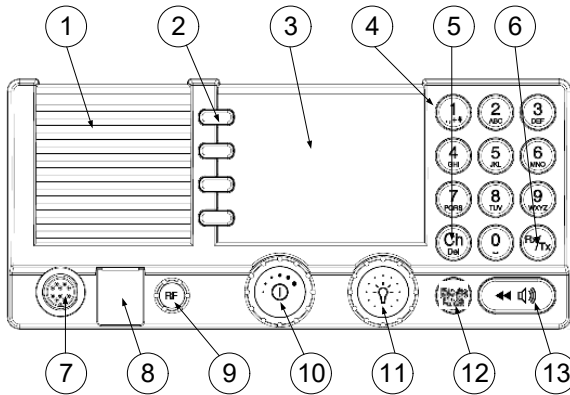

1. Loudspeaker.
2. Four soft keys with function title in the display.
3. Large TFT color display.
4. Alphanumeric keys to enter Rx or Tx frequency or text strings.
5. **CH** button for channel selection.
6. **Rx/Tx** button to enter Tx or Rx frequency.
7. Connector for handset or hand microphone.
8. **Distress** button for sending a Distress alert.
9. **RF** gain control.
10. Volume knob with push function for power on/off.
11. Selector and dim knob with push function for radio operation and setup.
12. **Mode/BAM** button:
  - **Mode** (short push): select the work mode: SSB, AM, LSB (optional), DSC, Telex (optional).
  - **BAM** (push and hold for 2 seconds): Enter the list of active alerts.
13. Replay button to play back up to 240 seconds of voice messages.

## Display overview

The picture shows the display after start-up. The display holds various fields of information, depending on the currently selected function.

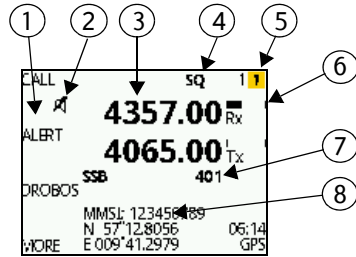

1. Functions you can select with the soft keys. If there are more than 4 functions in the list push the soft key **MORE** to display further functions.
2. Icon for speaker muted. Only shown when the speaker volume is turned down to zero. This icon does **not** apply to audible alarms, only to normal speaker sound.
3. Current receive and transmit frequency in kHz.
4. System property icons and engagement status.
5. Alert icon (check mark if no alerts).  
Push and hold Mode/BAM button to see a list of active alerts.  
The number next to the alert icon shows the number of unread alerts.
6. Channel properties with status and indicators for received signal strength (Rx) and transmission power (Tx).
7. Service line containing mode of operation and channel number.
8. DSC window with MMSI number, position information and source.

For a detailed description of the information shown for each of the functions available see the chapter *Operation* on page 9.

## Accessories available

Accessory	Description
<p>SAILOR 6201 Handset with cradle</p>	<p>One SAILOR 6201 Handset with cradle is included in the delivery of the SAILOR 6300 MF/HF DSC. If needed, you can connect another SAILOR 6201 Handset with cradle.</p> 
<p>SAILOR 6203 Handset with cradle</p>	<p>SAILOR 6203 Handset with cradle, waterproof to IPx6.</p> 
<p>SAILOR 6202 Hand Microphone</p>	<p>You can use the SAILOR 6202 Hand Microphone (waterproof to IPx6 and IPx8) instead of the handset.</p> 
<p>SAILOR 6207 Connection Box for parallel Handsets</p>	<p>The SAILOR 6207 Connection Box for parallel Handsets is used for easy installation of more than one handset.</p> 
<p>SAILOR 6208 Control Unit Connection Box</p>	<p>The SAILOR 6208 Control Unit Connection Box is used for easy installation of an additional SAILOR 6301 Control Unit.</p> 
<p>SAILOR 6209 Accessory Connection Box</p>	<p>The SAILOR 6209 Accessory Connection Box including Connection Cable 406209-941 is used for installation of external equipment:</p> <ul style="list-style-type: none"> <li>• Alarms, line audio and GNSS input</li> <li>• Additional Handsets</li> </ul> 

Accessory	Description
SAILOR 6103 Multi Alarm Panel	<p>With the SAILOR 6103 Multi Alarm Panel GMDSS Distress Alarms can be initiated and monitored. The Multi Alarm Panel is connected to the SAILOR 6300 MF/HF DSC via the Ethernet interface (LAN connector).</p> 
SAILOR 6081 Power Supply Unit and Charger	<p>The SAILOR 6081 Power Supply Unit and Charger provides DC power and automatically charges a connected battery.</p> 
SAILOR 6197 Ethernet Switch	<p>The SAILOR 6197 Ethernet Switch can be used in installations with SAILOR 6103 GMDSS Alarm Panels and in installations with ThraneLINK. The Ethernet switch has 5 ports.</p> 
SAILOR 6018 Message Terminal	<p>Used for the telex option. The terminal is used for composing, sending and receiving telex.</p> 
SAILOR H1252B Printer	<p>Printing option for telex.</p> 
SAILOR 6004 Control Panel	<p>Used for future features and as a DSC printing server.</p> 

# System configuration - example

## Transceivers TT-636xB and Antenna Tuning Unit TT-638xB

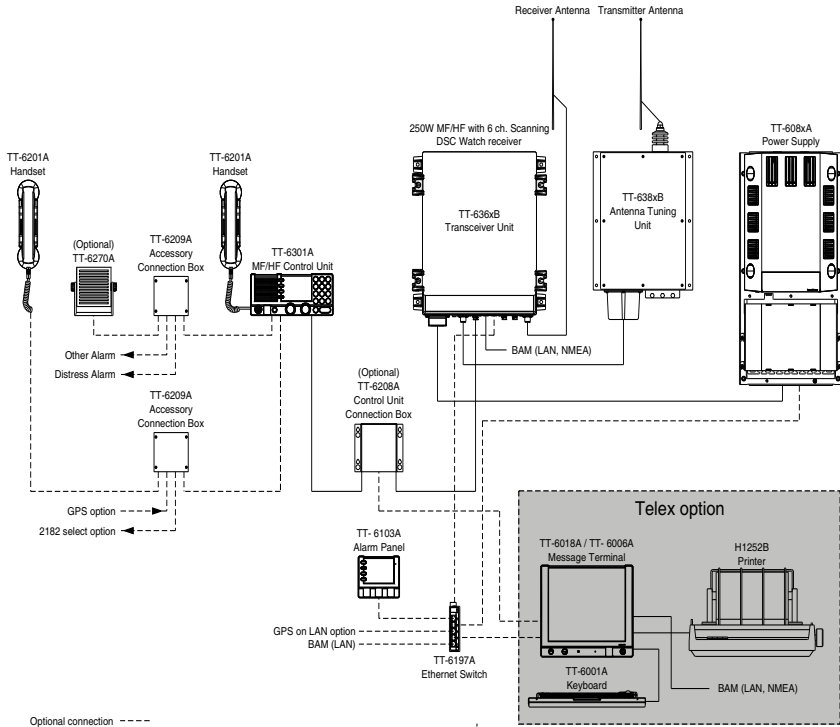

# Operation

## Overview

In this chapter you find detailed instructions and guidelines for:

- *General use and navigation*
- *Basic MF/HF radio communication*
- *Watch function*
- *DSC calls*
- *Handling multiple calls — DSC and voice*
- *Phone book*
- *Replay function*
- *Setup*

## General use and navigation

When the MF/HF radio is powered on for the first time, typically during installation, the vessel's MMSI number is entered. Hereafter the MMSI number is briefly displayed after power up. The MMSI is a unique, 9-digit identifier assigned to your ship.



**Caution!** Without a programmed MMSI number the Distress button will not work!

The message **NO DSC (NO MMSI)** is shown in the DSC window if the MMSI has not been programmed during installation.

## Power on, speaker volume and antenna tuning

The MF/HF radio has a dual-function on/off knob for power on/off and volume control.



Action	Procedure
Power on	push the on/off knob.
Power off	push and hold the on/off knob and follow the instructions in the display.
Speaker volume	Turn the volume knob (clockwise = louder, counterclockwise = softer, until muted). When muted,  is shown in the display.
Volume of the handset earpiece	To adjust the volume of the handset earpiece see <i>Controller setup</i> on page 49.
Tuning the antenna unit	<p><b>The radio tunes first time you push the PTT button on a new frequency.</b> <span style="border: 1px solid black; border-radius: 10px; padding: 2px;">Tune</span> As long as the tuning symbol is in the display, the radio is not transmitting. Wait until the tuning symbol has disappeared before talking. Tuning may take from 0.1 s to 8 s.</p> <p>Tuning is automatically done</p> <ul style="list-style-type: none"> <li>• after selection of a new frequency,</li> <li>• after a four hour time out</li> </ul>



## SSB, AM BROADCAST, DSC or TELEX mode

Push the **Mode/BAM** button to toggle between modes of the MF/HF radio.



**Short push** lets you select the mode:

- **SSB:** Upper side band mode used for standard MF/HF telephony.
- **AM:** AM broadcast is a listen-only mode for pleasure purposes except for 2182kHz on US equipment.
- **LSB:** Optional feature for listening to lower side band
- **DSC:** The MF/HF radio monitors a single DSC channel to be able to receive DSC calls.
- **TLX-SHIP:** The MF/HF radio monitors a single TELEX channel for telex communication using a SAILOR 6018 Message Terminal.

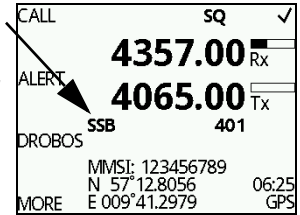

**Push and hold** brings up the list of active BAM alerts. BAM alerts are ship-internal alerts from connected equipment to the bridge. For details see *Alerts in the Bridge Alert Management (BAM) system* on page 58.

## Radio settings and ITU channel selection

To select an **ITU channel** push the channel button and

- turn the **selector knob** or
- press the numbers on the keypad.



## Entering Rx and Tx frequencies

To enter RX and TX frequencies use the RX/TX button and the keypad.



- First push on RX/TX button, enter Rx frequency and push OK.
- Push RX/TX button again to enter Tx frequency and push OK to select

- Push and hold RX/TX button to enter simplex frequencies and push OK. The same frequency is copied to both RX and TX fields on the radio.

For fine tuning of frequencies (voice clarify) push the selector knob.

Fine tuning step sizes		
Selector knob	SSB mode	AM mode
Push 1 x	10 Hz	100 Hz
Push 2 x	100 Hz	1000 Hz
Push 3 x	leave fine-tuning	leave fine-tuning

## Adjusting RF gain

Use RF gain to control audibility of the incoming signal. Turn the RF gain control knob fully:

- clockwise: maximum RF gain — maximum sensitivity
- anti-clockwise: minimum RF gain — minimum sensitivity



The larger the signal strength bar, the larger the signal must be in order to be audible. After entry of a new receive frequency the RF gain is set to maximum.

The function is enabled in SSB telephony and disabled in all other modes.

## Soft-key functions

A number of functions of the SAILOR 6300 MF/HF DSC are accessed using the four soft keys to the left of the display. The current function of a soft key is shown in the display next to the soft key.

The following soft-key functions are available from top-level standby:

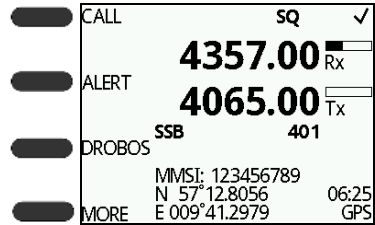

Soft key	Function
CALL	Make DSC non-Distress calls.
ALERT	Make a Distress call, categories can be assigned.
DROBOS	Distress relay call on behalf of someone else.
MORE	Display further soft key functions.
HI/LO <sup>a</sup>	Switch between high and low power.
WATCH <sup>a</sup>	Dual watch, current frequencies plus 1 DSC frequency (2177 kHz).
SCAN <sup>a</sup>	Scan in SSB voice or DSC + SSB voice mode. For scanned frequencies see <i>DSC Watch</i> in <i>Channel setup</i> on page 43.
MORE	Display further soft key functions.
SQLCH <sup>a</sup>	Squelch enable or disable <sup>b</sup> .
PHBOOK	Phone book.
SETUP	Setup pages. For more details see <i>Setup</i> on page 42.
MORE	Display further soft key functions.

- Only in SSB mode.
- Not available in WATCH mode.

## Position and MMSI Information

The position and MMSI information for the SAILOR 6300 MF/HF DSC radio is shown in the lower part of the display. The current (latest) position of the connected GNSS, the UTC and position type, GNSS Status and MMSI are displayed.

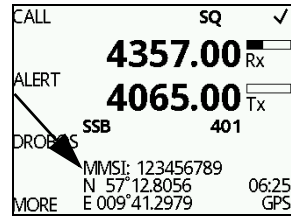

## Entering the vessel's position manually

If you need to enter the vessel's position and UTC of position manually, do as follows:

1. Push the soft key **SETUP**. If it is not in the display, push the soft key **MORE** until **SETUP** appears.
2. Push the arrow soft key ► or ◀ to advance to **DSC SETUP**.
3. Push the selector knob to select **Position & MMSI**.
4. Enter the current position and UTC time:
  - Latitude (LAT),
  - Longitude (LON)
  - UTC time (POS UTC)

Turn and push the selector knob to select the value you want to change. Then use the keypad or push and turn the selector knob to enter the current values for position and UTC time.

5. Having entered the UTC time, the soft key **SAVE** appears. If needed, you can clear all position data by pushing **CLEAR**. Push **SAVE** and then **EXIT** to return to normal operation. The display shows **MAN** in the lower right corner. (Manual time/position)
6. After you have entered a value manually or overruled the GNSS input, a soft key **Use GPS** appears in the display if the GNSS source is available. Push this soft key if you decide to use the data from a connected GNSS source.

If the GNSS source was present and then disappears a warning appears in the display after 10 minutes, then you can enter the position and UTC time manually as described above.

## Channel information always available in the display

For some functions and for the setup pages, the channel and radiotelephony information is moved to the bottom section of the display. You can change frequencies whenever the frequencies are displayed.

If **PTT** is pushed the radio transmits on the displayed frequency on which the radio is tuned into for communication. If a signal is received, it is received on the displayed frequency.

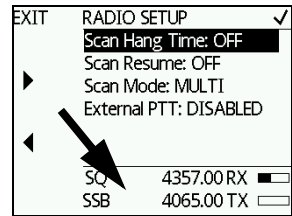

(Example: Radio setup)

## Engagement status

The radio is engaged when an active DSC-initiated communication is ongoing, or communication is active on non-DSC initiated MF/HF operation:

- A new channel is selected
- PTT is pushed
- Voice signal is received (if squelch is enabled)

The engagement state is used to prohibit incoming DSC calls from taking over control of the transmitter channel, disrupting ongoing communication.

When the radio is engaged in communication not initiated by DSC, this is indicated with the symbol  in the display. Engagement will automatically time-out on inactivity, after an inactivity time specified in *DSC setup* on page 44.

To terminate the engagement immediately push the soft key **QUIT**.

## Changing the display colors and dim function

Red text on black background is available for optimal night vision. To **dim the display backlight**, e.g. to give comfortable night vision, push, hold and turn the selector knob anti-clockwise. The display shows a brightness bar. At the brightness value 45 the display changes to **night view** with red text on black background.

To return to day vision push, hold and turn the selector knob clockwise until the display changes and it reaches the desired brightness.

The radio has two color themes: Black text on a white background (default) or white text on black background. To change the color theme see *System setup* on page 46.



## Squelch on/off (soft key)

By pushing the **SQLCH** soft key, the operator can activate a squelch function on the MF/HF system.

When squelch is enabled, use the **RF** gain knob to adjust the desired level of muting the noise signal.

In most cases, enable squelch when no signal is heard, turn the **RF** gain knob until the audio is muted. When a signal of greater level occurs, the audio will be unmuted.

For impact of squelch on replay see *Replay function* on page 41.

## Basic MF/HF radio communication

You can make radio calls using the Handset or another speaker device.

- Ship-to-ship communication: Use simplex channels.
- Ship-to-shore communication: Use duplex channels.

Only valid frequencies and channel numbers are accepted.

### Selecting SSB telephony frequency

1. Check that the MF/HF radio is in **SSB** mode. If necessary, push the button **Mode/BAM** to switch to **SSB**.
2. Enter an RX and TX frequency, for example **2182 kHz**, the international calling and Distress frequency for maritime radiotelephone communications on the marine MF bands.
  - First push on the RX/TX button: Enter Rx frequency.
  - Second push on RX/TX button: Enter Tx frequency.
  - Long push on selector knob: Edit mode to fine-tune frequencies. In SSB mode (Voice clarify), in 10 Hz steps. One more push changes the step size to 100 Hz.



### Receiving a SSB telephony call

When you hear your ship's name or call sign in the loudspeaker. Proceed as follows:

1. Take the Handset of the hook.
2. Push the **PTT** button and wait until the tune icon has disappeared. The symbol **TX** shows that the radio is transmitting on the frequency displayed and the transmission power bar shows output power.
3. Repeat the name of the station calling you and say: "This is [your ship's name]".

CALL	SQ	✓
	<b>4357.00</b>	Rx
ALERT	<b>4065.00</b>	Tx
	SSB	401
DROBOS	MMSI: 123456789	
	N 57°12.8056	06:25
MORE	E 009°41.2979	GPS



4. Suggest a frequency pair by saying: “Frequencies [suggested frequencies]” and “Over.” and release the **PTT** button to allow the caller to confirm the suggested new frequencies.
5. Switch to the new frequencies using the RX/TX button and the keypad and begin your conversation.

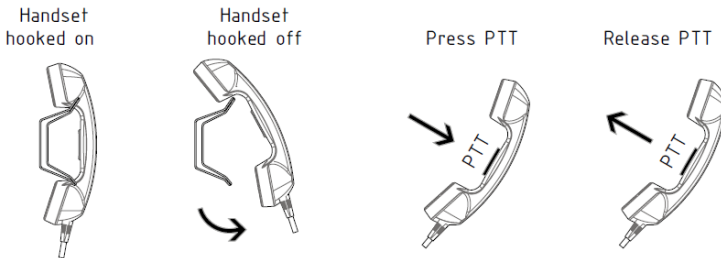

**Note**

**The radio tunes first time you push the PTT button on a new frequency.** As long as the tuning symbol is in the display, the radio is not transmitting. Wait until the tuning symbol has disappeared before talking. Tuning may take from 0.1 s to 8 s.

**Tune**

### Making an SSB telephony call

1. Enter RX and TX frequencies or select an ITU channel.
2. Lift the Handset or take a speaker device and push the **PTT** button, then wait until the tune icon has disappeared. The symbol **TX** shows that the radio is transmitting on the frequency displayed. The transmission power bar shows output power,

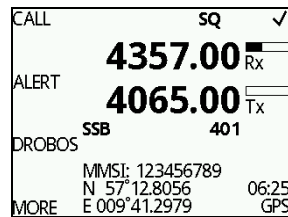

**Note**

If a popup window with the information **TX inhibit** is displayed when you want to make a radio call, your MF/HF radio is temporarily blocked for sending. Consult your radio responsible for information when you can start transmitting.

3. Say the name of the station you are calling three times.



4. Say: “This is [your ship’s name]” and “Over.” and release the **PTT** button to listen. The symbol **RX** shows that the radio is receiving on the working channel displayed.
5. When answered, agree upon a pair of frequencies, enter the new frequencies or ITU channel and start talking.

## Watch function

The MF/HF radio has a dual watch function. The currently selected RX and TX frequencies and the routine DSC frequency 2177 kHz are watched.

To start **WATCH** push the soft key **WATCH**. The display shows **SSB-DW:2177.00** (example).

To stop **WATCH** push the soft key **WATCH**.

## Scan

The radio has a scanning function for tagged voice channels. Any SSB voice channel can be tagged and added to the scanning sequence. In scan mode MULTI, the tagged SSB voice channels and the DSC channel are watched in turn (SSB voice — DSC — SSB voice 2 — DSC — etc). If a signal is received while in MULTI scanning mode, the DSC channel continues to be watched.

If there is a signal in one of the scanned channels, the display shows the channel in which the signal is received. If PTT is pushed while scanning, the scanning stops, the radio is tuned into the displayed channel and transmission starts immediately on the displayed working channel.

**To start scanning** push the soft key **SCAN**. The SCAN menu is shown. Push **START** to start scanning. To leave the SCAN menu, but not the scanning procedure, push **EXIT**.

**To stop scanning** push **STOP**.

**To tag a channel for scanning** select the wanted channel. Then push the soft key **TAG**. The display shows the channel number and the word **TAG** at the right side of the display.

**To remove a channel from the scanning sequence** turn the selector knob until the tagged channel is displayed. Then push the soft key **TAG** to remove the tag.

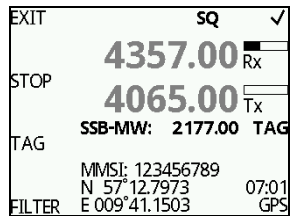
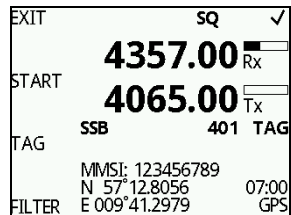

To see all tagged channels push the soft key **FILTER** and turn the selector knob. Push the soft key **EXIT** to leave the FILTER function. For details how to set up the scanning function see *Radio setup* on page 43.

**Note**

The displayed SSB channel is temporarily included in the scanning list (although no TAG icon is shown).

## DSC calls

In this section of the manual you find information on:

- *Own Distress — sending, acknowledging and canceling*
- *Sending a Distress from the SAILOR 6103 Multi Alarm Panel*
- *DROBOS — Distress relay on behalf of someone else*
- *Receiving Distress calls*
- *DSC calls*
- *Printing DSC calls*
- *Sessions in the MF/HF radio*
- *Handling multiple calls — DSC and voice*
- *Geographical area calls*

### Important

Some important words have a different meaning in DSC sessions compared to the BAM system.

#### Alert:

- In a DSC session an alert is a distress signal sent out over the air.
- In the BAM system, an alert is a ship-internal message from connected equipment bringing important issues to your attention on the bridge.

#### Acknowledge

- In a DSC session, a DSC call needs to be acknowledged by the receiving end. See *Own Distress — sending, acknowledging and canceling* on page 22.
- In the BAM system, you acknowledge that you have seen an alert, but the acknowledgment is ship-internal.

## Own Distress — sending, acknowledging and canceling

### To send a Distress alert

1. Lift the cover of the red Distress button and push and hold the Distress button for longer than 3 seconds. For short step-by-step instructions how to proceed when sending a Distress message see *Emergency calls*

ANNUL	OWN DISTRESS	✓
	WAIT FOR ACK: 0:01:28	
	REPEAT IN: 2:01	
FREQ	D.M.M.S.I: 123456789	
	NAT: UNDESIGNATED	
	LAT: N 57°12.7973 07:02	
	LOX: E 009°41.1505	
PAUSE	MODE: SSB	
	Bands: 2 4 6 8 12 16	
	8291.00 (RX)	<input type="checkbox"/>
MORE	SSB	8291.00 TX <input type="checkbox"/>



on page vi. When the Distress signal is sent, **SSB**, and **TX** appear in the display. A two-seconds beep tone is heard and the channel that is currently sent appears in the display. The MF/HF radio displays the bands in which the Distress has been transmitted. Sending multi channels distress requires HF DSC option.

If you inadvertently transmit a DSC Distress alert push the soft key **ANNUL**. For detailed instructions how to cancel all Distress alerts see *To cancel own Distress* on page 24.

2. Push the soft key **FREQ** if you want to specify a certain band out of the 6 available as the next distress frequency. Thereafter all 6 distress frequencies are transmitted.
3. Push the soft key **VIEW** (push **MORE** to advance to **VIEW**) to see details and start radio communication on the frequency 2182 kHz (automatically set) to inform about your Distress situation. (For a HF radio communication the frequency is on 8291 kHz)

**Note**

**Automatic retransmission:** If no Distress acknowledgment is received within a period of 3.5 to 4.5 minutes, the Distress message will automatically be retransmitted. Transmitting order: 2 MHz, 4 MHz, 6 MHz, 8 MHz, 12 MHz, 16 MHz.

For an undesignated Distress message the subsequent communication is always voice communication.

## ALERT — To send a Distress alert with specified parameters

To send a Distress call with specified nature, distress frequency and sub communication mode do as follows:

1. Push the soft key **ALERT**.
2. Enter the necessary information using the selector knob, see the following table.

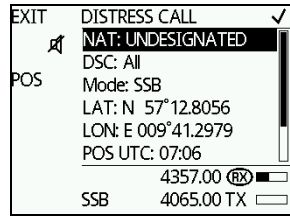

Item	Description
Distress nature	FIRE, EXPLOSION FLOODING COLLISION GROUNDING LISTING (in danger of capsizing) SINKING DISABLED (and adrift) UNDESIGNATED ABANDONING (ship) PIRACY (armed robbery attack) MAN OVERBOARD
DSC	All or single frequency, if you only want to send the Distress alert on one of the 6 Distress frequencies.
Mode	Radio sub communication mode: SSB or Telex FEC.

3. Lift the cover of the red Distress button and push the **Distress button** for 3 seconds.

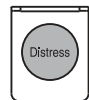

## To receive acknowledgment of own Distress

When the MF/HF radio receives an acknowledgment of Distress from another vessel or station, a 2-tone alarm sounds. The display shows a pop-up window with the MMSI number of the station who sent the Distress acknowledgment call.

- Push **SILENT** or any other key to switch off the 2-tone alarm.

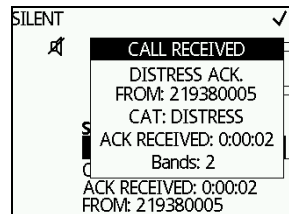

- Push the soft key **VIEW** to display further data for this call.
- Push **VIEW** again to return to the working display.

If the same own Distress acknowledgment comes in more than once, the 2-tone alarm sounds briefly and terminates automatically.

### To cancel own Distress

If you inadvertently transmit a DSC Distress alert and want to cancel it do as follows:

1. The display shows that a Distress message has been sent. Push the soft key **ANNUL**. A pop-up window is displayed.
2. Push the soft key **YES** to go ahead with the canceling process, or push the soft key **NO** to return to Distress sending procedure.
3. You must send a voice cancellation message on all DSC watch channels. The display shows the message that you should say when canceling the Distress.

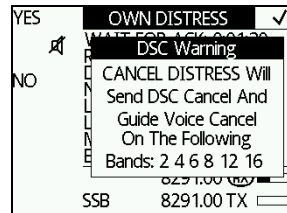
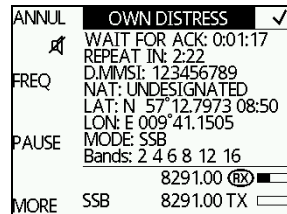

Use the selector knob to scroll through all information for the voice cancel.

4. Push the soft key **OK** to go to the next Distress frequency and repeat step 3.  
Once you have made the voice cancel for all Distress frequencies, Own Distress is canceled.
5. To finish the Distress session and get back to normal radio use push the soft key **QUIT**.

## Power failure while in Distress

In case of a power failure or switch-off during the transmission of a Distress the SAILOR 6300 MF/HF DSC gives an audible warning after power-up and automatically resumes sending Distress 10 seconds after power up. Within the 10 seconds you have the following options:

- Push **QUIT** to terminate the active Distress procedure (acknowledged or unacknowledged).
- Push **RESUME** (or do nothing) to resume the sending Distress procedure.

## Sending a Distress from the SAILOR 6103 Multi Alarm Panel

The optional SAILOR 6103 Multi Alarm Panel will, when connected to the MF/HF radio, indicate in the SAILOR 6103 display that a Distress can be sent over MF/HF.

**Note**

Only undesignated Distress messages can be initiated from the Alarm Panel.

To send a Distress alert from the SAILOR 6103 Multi Alarm Panel, do as follows:

1. Lift the cover of the Distress button marked **MF/HF Distress**.
2. Push and hold the button until the light is steady and the buzzer stops (more than 3 seconds).

The MF/HF radio is now in Distress mode. Continue the Distress procedures from the MF/HF radio front panel.

3. Push the **MUTE** button on the Alarm panel to mute the audible alarm for current distress. All audible alarms are muted.

For further information see the Alarm Panel Installation and user manual.

## DROBOS — Distress relay on behalf of someone else

To send a Distress message on behalf of someone else, do as follows:

1. From top-level standby push the soft key **DROBOS**.
2. Select one line at a time by pushing and turning the selector knob.
3. Enter the necessary information using the selector knob or the keypad:

EXIT	DISTRESS RELAY	✓
	Type: RELAY INDIV.	
	DISTRESS MMSI:	
PHBOOK	Unknown	
	TO:	
	DSC: 2187.50	
	Mode: SSB	
	4357.00	<input checked="" type="checkbox"/>
	SSB	4065.00 TX <input type="checkbox"/>

DROBOS items	Description
TYPE:	Select RELAY INDIV or RELAY AREA.
Distress MMSI:	Enter the MMSI number of the vessel in Distress, if known, or else “unknown”
TO:	Enter the MMSI number of the coast station you are relaying the Distress alert to.
DSC:	Enter the DSC frequency pair, 6 are available, default: 2187.5 kHz.
Mode:	Select the radio sub communication mode: SSB or Telex FEC.
NAT:	Select the nature of Distress, see <i>ALERT — To send a Distress alert with specified parameters</i> on page 23.
LAT: LON: POS UTC:	Enter the position data.

4. Push the soft key **SEND**.



## Receiving Distress calls

When the radio receives a Distress call, the 2-tone alarm sounds. The display shows the bands in which the Distress call is received and the category of the Distress call. The types of Distress calls are Distress, Distress ACK, Distress RELAY and DISTR. RELAY ACK.

### Note

There are also a number of BAM alerts associated with incoming DSC calls. For details, see *List of BAM alerts* on page 61.

1. Push the soft key **SILENT** to switch off the 2-tone alarm.
2. Push **VIEW** to display further information for this call.
3. Push **HOLD** to put the call on hold and stay in the communication loop to receive follow up information, updates etc.
4. Monitor radio communication on the frequency 2182 kHz (automatically set) as a coast station may require your assistance. (If Distress is received on HF radio communication, the frequency is 8291 kHz)
5. The radio receives the first Distress acknowledgment call and the 2-tone alarm sounds again. To switch off the 2-tone alarm push the soft key **SILENT**.
6. If you decide to acknowledge the Distress call push the soft key **ACK** (push **MORE** until **ACK** is shown in the display).

You can also relay the Distress call. Enter a new MMSI to which you want to send the Distress call, then push the soft key **SEND**.

## Distress call with errors

Distress calls containing errors can be received. Push the soft key **VIEW** to view the message; errors are shown as underscores (\_).

DSC Call Received
<p style="text-align: center;"><b>GROUP (ERR)</b> FROM: 123456789 CAT: DISTRESS</p>

## Distress call log

As long as you are part of a Distress session, i.e. you have not pushed **QUIT**, you receive Distress messages and can track all Distress messages for the current Distress event.

1. Push the soft key **LOG**. If it is not in the display, push the soft key **MORE** until **LOG** appears.
2. Push the soft key **NEXT** and **PREV** to browse the received Distress messages.
3. Push the soft key **EXIT** to leave the log.

## DSC calls

With a DSC call you can establish a radio communication with one or several specific radios on a suggested pair of frequencies or channel.

 <p><b>MF/HF Radio A</b></p>	<ol style="list-style-type: none"> <li>1. Make a <b>DSC call</b> from Radio A to Radio B.</li> <li>2. <b>DSC acknowledge</b> from Radio B to Radio A.</li> <li>3. Radio A + B go on the <b>agreed MF/HF channel</b>.</li> <li>4. Press <b>PTT</b> and start talking.</li> </ol>	 <p><b>MF/HF Radio B</b></p>
---	---	---

To make a DSC call, do as follows:

1. Push the soft key **CALL**. The default call is an individual routine call.
2. Turn and push the selector knob to select a call type. For each DSC call type a number of parameters can be set.

EXIT	DSC CALL	✓
	Type: INDIVIDUAL	
	Cat: ROUTINE	
PHBOOK	To:	
	DSC: 2177.00	
	Mode: SSB	
	Freq: 2265.00	
	4357.00	(RX) <input type="checkbox"/>
	SSB 4065.00 TX	<input type="checkbox"/>

DSC call type	Cat	To:	DSC:	Mode	CMD	Ch	DEST CENTRE + RADIUS
INDIVID.	X	X	X	X	—	X	—
SATETY TEST	—	X	X	—	—	—	—
Position	—	X	X	—	—	—	—
Group	—	X	X	X	—	X	—
Area	X	—	X	X	X	—	X

3. Make the entries for the desired call type:

Item	Description
TO:	Enter the 9-digit MMSI number of the vessel you want to contact or use the phone book ( <b>PHBOOK</b> ) to select a contact.
DSC:	Enter a frequency for the DSC call.
Mode:	Select the sub communication mode SSB or TELEX FEC.
Cat:	Select a DSC call category, depending on the call type (Routine <b>R</b> , Safety <b>S</b> or Urgency <b>U</b> )
CMD:	Select Medical transport or Neutral crafts (if enabled in <i>DSC setup</i> on page 44). Only for the category: Urgency calls.
Ch:	Enter the suggested frequencies for voice communication.
DEST CENTRE + RADIUS	For Area calls enter the destination center with latitude and longitude data, plus the destination radius in nm. For information about how areas must be entered see <i>Geographical area calls</i> on page 37.

4. Push the soft key **SEND** to make the call.

**Note**

Routine calls on e.g. 2177 kHz are not automatically monitored on all radios. Enabling DSC mode on 2177 kHz or dual watch or scan will monitor the channel on SAILOR 6300 MF/HF

## Printing DSC calls

If a printer is connected to the SAILOR 6300 MF/HF DSC via LAN you can print DSC messages automatically. You can also print entire DSC call logs.

To set up a default printer, do as follows:

1. Go to **SETUP** and use the arrow keys to advance to **System Setup**
2. Select **Printer Config:**
3. Select one printer as the default printer and push the selector knob to enter the choice.

To print DSC messages, do as follows:

1. Go to **SETUP** and use the arrow keys to advance to **DSC Setup**.
2. Use the selector wheel to scroll to **Print DSC**.
3. Set **Print DSC:** to **ON**.

To print DSC call logs, do as follows:

1. Go to **SETUP** and use the arrow keys to advance to **DSC call logs**.
2. Select the call log you want to print.
3. Push the soft key **PRINT**.

A printer attached to the SAILOR 6004 Control panel can be used, or a generic LAN based line printer.

**Note**

DSC logs can also be downloaded accessing the IP address of the radio with a standard web browser.

## Sessions in the MF/HF radio

### What is a session?

A DSC session is defined as a collection of DSC calls (transmitted and/or received) that are related to the same event (e.g. a Distress event) or established call (e.g. an individual call request followed by an acknowledgment).

A session can be either **active** or **on hold**. The active session has control over the radio transmitter. A session can have a purpose. For example if the purpose is to establish a communication on a working channel.

The non-DSC communication (voice) is considered as a session that can be active (engaged) or on hold (dis-engaged). See also *Engagement status* on page 15.

### Display for a session

In the lower part of the display the type of session, the current state, MMSI number of the other party and lapsed time since the reception of a call request or an acknowledgment is shown.

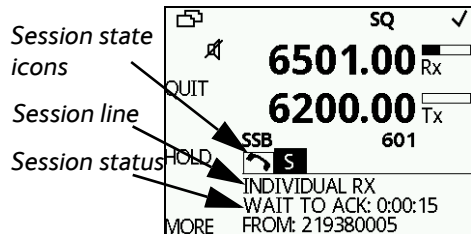

The session state icons, in the example  and **S**, show the state of the session:

- **ACTIVE** — the session icon is inverted, the transmitter tuned into the communication channel (in the example **S**, a DSC Safety call).
- **HOLD** — normal view, parked session (in the example , MF/HF voice communication).

For more information on the session state icons see *Session state icons* on page 32 below.

#### Note

If two identical polling or test calls are sent from the same MMSI and the operator wants to resend a confirmation to the second call received, put the session on hold and then activate it again.

### Session state icons

Session icons in the session view inform you of the severity or category of the DSC call or Voice communication:

- **D** — Distress category
- **U** — Urgency
- **S** — Safety
- **R** — Routine
-  — Voice (voice call, non-DSC)
- **T** — Telex

### Session line

The following table gives an overview of the information in the session line:

Session line	Explanation
OWN Distress	The ship is in own Distress. See also <i>To send a Distress alert</i> on page 22.
Distress RX	You watch or participate in a Distress communication for another station in Distress
RELAY calls (numerous)	You watch or participate in a Distress communication for another station in Distress
ALL SHIPS TX/RX	You have sent / received an all ships call
GROUP TX/RX	You have sent / received a group call
INDIVIDUAL TX/RX	You have either sent a call request to a station to establish contact, or another station has made a call to you to establish contact. The call needs a reply.
TEST TX/RX	You either have sent a SAFETY TEST call or have received a SAFETY TEST call from another station that needs to be replied.
POSITION TX/RX	A position request was either sent or received.

## Session status

The following table gives an overview of the information in the session status:

Session status	Explanation
WAIT FOR ACKNOWLEDGE	You made an individual call to a station and are awaiting a reply to establish connection.
OCCUPIED	The DSC transmission mechanism waits until the selected DSC channel is free.
TRANSMITTING	Transmission of a DSC message is ongoing.
IN COMMUNICATION WITH	The communication has been established
ACKNOWLEDGED	Pertinent to distress call sessions
LINK FOR COM	Pertinent to Area and Group call sessions

## Soft keys for DSC sessions

Call/session types vary in control options, and options may also change if a session changes its state. The following table gives an overview of the DSC soft key commands available:

Soft key — DSC session	Radio function
QUIT	Terminates the DSC session
HOLD	Puts the DSC session on hold if it is active (return to other non-DSC functions)
ACTIVE	Activates the DSC session
VIEW	Shows details about the DSC call
RESEND	Transmits an identical call if available

Soft key — DSC session	Radio function
NEWCH	Replies with a new channel if an individual call is received with a communication channel specified which is not available in the radio, or the operator decides to change the channel.
UNABLE	Constructs a reply to the caller if an individual call is received which is not compatible with the radio modes.
SILENT	Silences alarms. Any key silences the alarm but this soft key function will do only this.
ACK	Acknowledges a received call request with the suggested parameters.
POS (Own Distress)	A shortcut to own position data information.
PAUSE (Own Distress)	Pauses the automatic repetition of Distress transmissions
RESUME (Own Distress)	Resumes automatic repetition of Distress transmissions (if paused)
RELAY	Relay a received Distress call.
ANNUL (Cancel Own Distress)	Cancels an inadvertently transmitted Distress
CONFIRM (Cancel Own Distress)	Confirms action and proceed sequence, used in cancel Distress procedure
INFO (in Cancel Own Distress)	Turns page of text message.
HIST (Received Distress)	A filtered version of the log displaying received calls relevant to the current Distress event.

You find detailed information how to handle multiple calls in *Handling multiple calls — DSC and voice* on page 36.



## Information for DSC sessions (soft key: **VIEW**)

A DSC session is updated based on DSC calls received or transmitted. Push the soft key **VIEW** to show the details for the current session. For Distress events a sequence of calls may contribute to the complete view and status of the session. Detailed fields for Distress are:

Details — Distress	Explanation
DISTR-MMSI	The vessel in Distress
NAT	Nature of Distress
LAT	Latitude position of station in Distress
LON	Longitude position of station in Distress
POS UTC	Time of position
MODE	Communication mode (SSB, Telex)
2 4 6 8 12 16	Frequency bands for Distress alerts

For other session types the soft key **VIEW** typically shows the details from a single call. Detail fields for other calls than Distress are:

Details —other calls	Explanation
CALL Type	(on received call) – The call type may be shown on call reception
CAT	Category of the call: Urgency, Safety or Routine
FROM	The initiator of the call
TO	The intended receiver of the call (unless All Ships)
MODE	Communication mode (Simplex/Semi-duplex Telephony supported)
CHANNEL	Subsequent communication channel

Details —other calls	Explanation
LAT	Latitude position returned upon a position request
LON	Longitude position of station in Distress
POS UTC	Time of position

### Receiving DSC calls

If the radio is in stand-by mode, i.e. not engaged in another session, and a DSC call is received the call details are shown on the display.

Push the soft key **SILENT** to continue.

You can acknowledge the call, put it on hold or display more information (soft key:

**VIEW**). If you put the call on hold, the session icon for this call will flash until you have acknowledged the call. See also *Display for a session* on page 31.

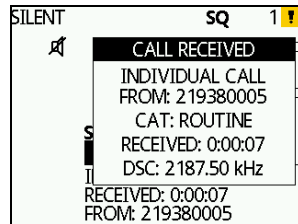

### Handling multiple calls — DSC and voice



The SAILOR 6300 MF/HF DSC can control multiple DSC sessions simultaneously including a voice communication session. All sessions keep track of their session state and the communication channel used.

**Note** | Note that there is one active call or session at a time. Use the soft key  to switch between the ongoing calls/sessions.

A call or session can be on hold (**HOLD**) or active (**ACTIVE**). If there are several calls ongoing, they are shown as tabs in the display with their state (active, on hold, requiring attention). The DSC sessions on

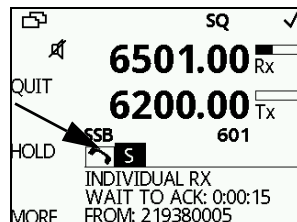

hold can receive calls that are pertinent to the session, even when the session is not displayed.

To close a session, the session must be active, then push the soft key **QUIT**.

In case there are simultaneous alarms, they are sorted according to their priorities, the most important ones are shown first. In some cases alarm or pop-up messages terminate automatically, then the display messages and audible alarms also disappear automatically.

## Geographical area calls

When making a DSC area call, enter the position of the ship  $(x,y)$  and the radius of interest  $r$ . This information is transformed to a square with a corner point  $(a,b)$  and the length of its sides,  $\Delta a$  and  $\Delta b$ . Then the DSC message is transmitted. The illustration on this page shows the relation between the user input — the white circle — and the information transmitted — the gray square. The center point is the position of the ship measured in degrees and minutes, whereas the radius of interest is in nautical miles.

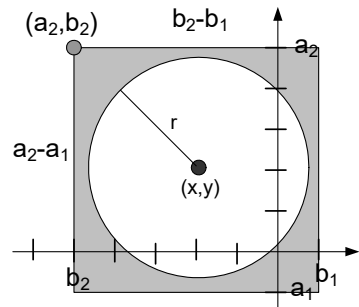

The corner point of the square  $(a_2, b_2)$  and the length of its sides is given in degrees. Note that these values are rounded to degrees, and due to the requirement that the square shall include the entire circle; this will result in a slightly larger area than defined by the user input.

Attention when close to the poles: If the latitude of the corner point 'a' is transformed to a value greater than  $90^\circ$  then it is set to  $90^\circ$  and the length  $\Delta b$  is reduced correspondingly. If the length  $\Delta a$  is greater than  $90^\circ$  then  $\Delta a$  is set to  $90^\circ$ .

## Phone book

Use the phone book when making a DSC call. You can enter up to 50 contacts. The phone book is always sorted alphabetically by contact names. To sort phone book contacts use the soft key **FILTER**. The contacts can be sorted in ALL, COAST, SHIP or GROUP.

### Using the phone book to make a DSC call

To call a contact using the phone book do as follows:

1. Push the soft key **CALL**. If it is not in the display, push the soft key **MORE** until **CALL** appears. The DSC call composer is shown in the display.
2. Push the soft key **PHBOOK**.
3. Turn the selector knob to scroll to the phone book entry that you want to call and push the selector knob to select the contact.
4. Push the soft key **SEND** to make the call.

### Adding a contact to the phone book

To add a contact to the phone book do as follows:

1. Push the soft key **PHBOOK**. If it is not in the display, push the soft key **MORE** until **PHBOOK** appears in the display.
2. Push the soft key **ADD** and fill in the details for the new contact.

Contact	Description
NAME	Enter the name by turning the selector knob to the desired letter, push the selector knob to accept the letter and advance to the next letter. To finish push the soft key <b>OK</b> .
TYPE	Push and turn the selector knob to select SHIP, GROUP or COAST STATION.

Contact	Description
MMSI	Turn and push the selector knob to enter the contact's MMSI number (9 digits), push the soft key <b>OK</b> to accept. For coast station contacts you can also enter a DSC channel.
Ch (optional)	Push and turn the selector knob to select the preferred channel for this contact, push the soft key <b>OK</b> .
Position Auto Ack	For SHIP or COAST STATION: Push and turn the selector knob to select YES or NO for this contact, push the soft key <b>OK</b> . This will allow auto-acknowledgment of position requests for this contact.
Listen to Group	For GROUP: Push and turn the selector knob to select YES or NO for this contact, push the soft key <b>OK</b> . The radio will respond to calls to the specified group.

3. Push the soft key **SAVE** to save the contact information.
4. Push the soft key **EXIT** to leave the phone book.

## Editing a contact

1. Push the soft key **PHBOOK**. If it is not in the display, push the soft key **MORE** until **PHBOOK** appears.
2. Push the soft key **EDIT**.
3. Push and turn the selector knob to browse through the details of the contact and continue as described in *Adding a contact to the phone book* from step 2 onwards.

## Deleting a contact

1. Push the soft key **PHBOOK**. If it is not in the display, push the soft key **MORE** until **PHBOOK** appears.
2. Turn the selector knob to browse to the contact you want to delete.

3. Push the soft key **MORE** until **DELETE** appears.
4. Push the soft key **DELETE**.
5. Push **EXIT** to leave the phone book and return to radio operation.

## Radiotelex

With the Radiotelex system you can send and receive telex messages over MF/HF radio. The Radiotelex program runs on a SAILOR 6018 Message Terminal with a keyboard. The SAILOR 6018 Message Terminal is connected to a System 6300 MF/HF radio, which transmits and receives the radio telex messages.

In order to send and receive telex messages push the **Mode/BAM** button of the MF/HF radio until **TLX-SHIP** is shown in the display.



For detailed instructions on how to send a radio telex message see the **SAILOR 6000 MF/HF Radiotelex**, User Manual.

## Replay function



With replay you can playback received voice messages in the loudspeaker. Recording is activated automatically when a signal is received. Recording is not possible during playback. Up to 60 tracks or 240 seconds can be handled.

**Note** | To record messages only (without the continuous background noise) activate the squelch function. Push the soft key **SQLCH**.

The recorded channel is displayed and the message length is shown in seconds. The display shows also how old the message is. If the 240 seconds storage limit is reached, the oldest data is overwritten.

**Note** | The replay function can be started even in a Distress situation. If a DSC call is received the replay function continues the playback.

### Replaying recorded messages

Push the replay button to replay a recorded message. The latest message is repeated. Information about this message is shown in the display. If a signal is received while in replay mode the display shows **RX** in the display.

To stop replaying the message push the soft key **STOP**. To skip through all recorded messages push the replay button repeatedly at short intervals.

## Setup

The following setup pages are described in this section of the manual:

- *Radio setup*
- *Channel setup*
- *Power Supply*
- *DSC setup*
- *DSC call logs*
- *System setup*
- *Controller setup*
- *Diagnostics*
- *System config*

### Accessing a setup page

To change a setting in one of the **SETUP** pages, do as follows

1. Push the soft key **SETUP**. If it is not in the display, push the soft key **MORE** until **SETUP** appears.
2. Push the arrow soft key **▶** or **◀** to advance to the **SETUP** page you want to edit.
3. Turn the selector knob to go to a setting, then push the selector knob to change the setting.
4. Push **EXIT** to return to normal radio operation.



## Radio setup

Item	Description
Scan Hang Time	Scan hang time, in seconds on an active receiving working channel. The time is measured from the signal is detected. The radio remains on the channel for the set time interval, if a signal was detected.  <b>OFF:</b> Resumes scanning when signal disappears (default) <b>4, 6, 8, 10:</b> Hang time in seconds.
Scan Resume	Scan resume time, in seconds. When the programmed time of inactivity has elapsed, and when watch/scan has been aborted using a push on PTT, or after power-up, scan or watch is resumed.  <b>OFF:</b> Automatic resume is deactivated (default) <b>3, 6, 10, 15, 20, 25, 30:</b> Resume time in seconds.
Scan Mode	Scan mode when pushing the soft key <b>SCAN:</b> — VOICE (SSB voice) or — MULTI (DSC plus SSB voice, alternating)
External PTT	ENABLED (For use of an external PTT device, connected to the TU AUX plug) or DISABLED

## Channel setup

Item	Description
Watch Receiver	Push the selector knob to display the watch frequencies and to show which of these are enabled. Contact your local distributor for modifications.
Private Channels	Read only. Contact your local distributor for adding private channels.
DSC Watch	The frequency watched for dual watch or multi scan. To receive routine DSC calls set this frequency to 2177.

## Power Supply

Item	Description
Supply Voltage	Shows the voltage on the supply terminals.
Charger Monitor	Set to <b>ENABLED</b> to monitor charging information from a connected SAILOR 6081 Power Supply Unit and Charger.
Status	Visible if <b>ENABLED</b> . Current status of the connected power supply.
Battery Voltage	Visible if <b>ENABLED</b> . Current battery voltage.
Charging Current	Visible if <b>ENABLED</b> . Current charging current.

## DSC setup

Item	Description
Position & MMSI	Available position information. Here you can enter position data and UTC time manually. See also <i>Position and MMSI Information</i> on page 14 for a step-by-step description.
DSC Groups	Create, view, and filter DSC groups.
Auto-Ack Test	Auto-acknowledgment of test DSC messages <ul style="list-style-type: none"><li>• OFF – Disabled</li><li>• <b>ON</b> – Enabled (default)</li></ul>
Auto-Ack Polling	ON or OFF
Auto-Ack Position	ON or OFF

Item	Description
Auto-Ack Individual	Auto acknowledgment of individually addressed, non Distress DSC messages <ul style="list-style-type: none"> <li>• OFF – Disabled</li> <li>• <b>ON</b> – Enabled (default)</li> </ul>
Non-Distr. Inactivity	Inactivity time-out to exit non-Distress functions (e.g. in setup) without automatic time-out: Range: OFF, 1 to 30 minutes, in 1 min. steps Default: <b>15 min.</b>
Distress Inactivity	Inactivity time-out for received Distress DSC automated procedures without automatic time-out: Range: OFF, 1 to 30 minutes, in 1 min. steps Default: <b>OFF</b>
Comm Inactivity	Inactivity time-out of non DSC communication. Range: 10 to 600 seconds, in 10 second steps Default: 30 seconds
Non-Distr. Alarms	Non-Distress DSC alarms <ul style="list-style-type: none"> <li>• CONTINUOUS</li> <li>• <b>SELF TERMINATING</b> (default)</li> <li>• OFF</li> </ul>
Self-Term. Distr. Alarms	Alarm type for distress alarms received from a distance further than 500 nm away. <ul style="list-style-type: none"> <li>• Self Terminating</li> <li>• DISTRESS Alarm</li> </ul>
Medical transport	<ul style="list-style-type: none"> <li>• ON: This option is available in DSC calls of the type Urgency.</li> <li>• OFF</li> </ul>
Neutral crafts	<ul style="list-style-type: none"> <li>• ON: This option is available in DSC calls of the type Urgency.</li> <li>• OFF</li> </ul>

Item	Description
Print DSC	<ul style="list-style-type: none"> <li>• ON: Automatic printing of DSC messages on a selected network printer, accessible via LAN.</li> <li>• OFF</li> </ul>
DSC Self Test	<ul style="list-style-type: none"> <li>• <b>OFF</b>: Disabled (default), no DSC self test.</li> <li>• RUN: Run a DSC self test. For further details about this test see <i>DSC self test</i> on page 54.</li> </ul>





## DSC call logs

DSC call log	Description
Received Distress	Shows a log of up to 20 received Distress calls.
Transmitted Calls	Shows a log of up to 20 transmitted calls.
Received Calls	Shows a log of all received non Distress calls.

## System setup

Item	Description
Printer Config	Select a printer (if one or several printers are part of the system). For further information see <i>Printing DSC calls</i> on page 30. Recommended commercially available printer-servers: <ul style="list-style-type: none"> <li>— Trendnet TE100 P1U</li> <li>— D-Link DPR-1020</li> <li>— SAILOR 6004 Control Panel</li> </ul>
System time & Date	View and set system time and date.

Item	Description
Inactivity timeout	<p>Inactivity time-out to exit functions (e.g. in setup) and return to the application.</p> <p>Range: 1 to 30 minutes, in 1 minute steps Default: <b>10 min.</b></p>
Language	English
Theme	<p>Changes the display color.</p> <ul style="list-style-type: none"> <li>• 0: BlackOnWhite</li> <li>• 1: WhiteOnBlack</li> </ul>
GNSS Input	<p>Select the position input source</p> <ul style="list-style-type: none"> <li>• <b>Automatic:</b> Automatically select position source with the best quality.</li> <li>• CU NMEA: Low speed NMEA position input on Control Unit</li> <li>• TU SYSCON: Low speed NMEA position input on Transceiver System Connector</li> <li>• TU AUX: Low speed NMEA position input on transceiver Auxiliary Connector.</li> <li>• LWE1-3: Specific LWE position input. (See LWE Talkers below)</li> <li>• INM-C: Inmarsat C position input</li> </ul> <p>In <b>Automatic</b> mode the position device transmitting sentences with the best quality indicator will be used as position source.</p> <p>- Current Src Report the current input used as the position source</p>

Item	Description
NMEA in (baud) (only displayed when NMEA TU or NMEA CU is selected)	The actual baud rate of the NMEA input port selected  4800
LWE Talkers (only displayed when Automatic or one of the LWE sources is selected)	When Automatic mode is selected <b>updating</b> is shown to indicate the equipment is currently scanning for devices on the LAN network.  This process may take up to 40 seconds.
- LWE1 - LWE2 - LWE3  Or -  LWE1 -  LWE2 -  LWE3	<p><b>CCXXXX</b> In automatic mode this position holds the highest priority GNSS position source after a scan.</p> <p>If a third party position source shall be used in the LWE priority, the LWE talker is simply programmed on the desired priority position (LWE1, LWE2 or LWE3). A manually programmed source is indicated by a key symbol (). The manually programmed LWE sources can be removed by deleting the entry completely.</p>
LWE Identity	<p><b>CCXXXX</b> As default the device identity is automatically created. Manual override requires password entry.</p>
Factory Defaults	Resets the radio to factory defaults after power cycle.
Password	If you need to change the identity of the radio (MMSI number or disabling the ATU), contact your local dealer.
Radio info	<ul style="list-style-type: none"> <li>• SW Version: Software version of the Transceiver Unit</li> <li>• S/N: Serial number of the of the Transceiver Unit</li> <li>• TU IP: IP address of the Transceiver Unit</li> </ul>

## Controller setup

Item	Description
Handset 1 vol:	<p>Adjust earpiece volume for handset 1: can be adjusted from 0 to 100, in steps of 5.</p> <p><b>Note:</b> Default setting is <b>80</b>. The handset connected to the front connector has top priority and is configured to 80. The volume can be adjusted from 0 to 100, in steps of 5.</p>
Handset 2 vol:	<p>Adjust earpiece volume for handset 2: can be adjusted from 0 to 100, in steps of 5.</p> <p><b>Note:</b> Default setting is 0. If a handset is connected to the rear connector this value must be configured to a value (0 to 100, in steps of 5).</p>
Wheel lock:	<p>You can set a time interval after which the RF gain, volume and selector knobs are locked and protected against unintentional use. Then a lock symbol is shown in the display. Push any key to unlock the knobs.</p> <p><b>OFF</b>, 10s, 20s, 30s, 40s, 50s, 60s</p>
High priority	<ul style="list-style-type: none"> <li>• Yes — This MF/HF radio (Control Unit) can override the other Control Unit connected to the same Transceiver Unit.</li> <li>• No — This MF/HF radio (Control Unit) cannot override the other Control Unit.</li> </ul>
Controller Info	<ul style="list-style-type: none"> <li>• SW Version: Software version of the Control Unit</li> <li>• S/N: Serial number of the of the Control Unit</li> <li>• IP: IP address of the of the Control Unit</li> </ul>

## Diagnostics

Item	Description
Diagnostics	<p>In this menu you can view a log with system status messages and you can start a system test of the SAILOR 6300 MF/HF DSC:</p> <ul style="list-style-type: none"> <li>— Log</li> <li>— System Test</li> <li>— ATU Status</li> </ul> <p>For more details on the Log and Self Test see <i>Diagnostics</i> on page 66.</p>

## System config

The system config menu allows the operator to input purchased option keys for telex and HF DSC. Furthermore, status on telex and HF DSC can be validated in this menu (e.g. to be presented for a surveyor).

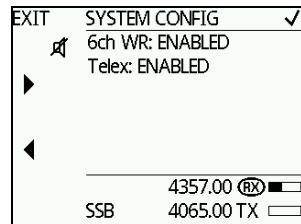

**Note**

Telex option must be enabled in order for the transceiver to communicate with the optional Message Terminal.



## Top-level soft key functions and setup pages

TOP LEVEL SOFT KEYS	
CALL	EXIT PHBOOK
ALERT	EXIT POS
DROBOS	EXIT PHBOOK
HI/LO*	
WATCH*	
SCAN*	EXIT START STOP TAG FILTER
SQLCH*	
PHBOOK	EXIT ADD FILTER
SETUP	EXIT ▶ ◀

\* Only in SSB mode.

SETUP PAGES	
RADIO SETUP	Scan Hang Time Scan Resume Scan Mode External PTT
CHANNEL SETUP	Watch Receiver Private Channels DSC Watch
POWER SUPPLY	Supply Voltage Charger Mon. Status** Battery Voltage** Charging Current**
DSC SETUP	Position & MMSI DSC groups Auto-Ack Test Auto-Ack Polling Auto-Ack Position Auto-Ack Individual Non-Distr. Inactivity Distress Inactivity Comm Inactivity Non-Distr. Alarms Self-Term. Distr. Alarms Medical transport Neutral crafts Print DSC DSC Self Test
DSC CALL LOGS	Received Distress Transmitted Calls Received Calls
SYSTEM SETUP	Printer Config System time & date Inactivity timeout Language Theme GPS Input NMEA in LWE Talkers LWE Identity Factory Defaults Password Radio info
CONTROLLER SETUP	Handset 1 vol Handset 2 vol Wheel lock High priority Controller Info
DIAGNOSTICS	Log Self Test ATU Status
SYSTEM CONFIG	6ch WR Telex

\*\* If Monitor is set to ENABLED



# Service & maintenance

## Overview

In this chapter you find detailed information on:

- *Contact for support*
- *Maintenance*
- *Troubleshooting*
- *Alerts in the Bridge Alert Management (BAM) system*
- *Diagnostics*
- *Warranty and returning units for repair*

## Contact for support

Contact your authorized dealer for technical service and support of the MF/HF radio. Before contacting your authorized dealer you can go through the troubleshooting guide to solve some of the most common operational problems.

## Maintenance

### Preventive maintenance

Maintenance of the SAILOR 6300 MF/HF DSC can be reduced to a weekly check and a maintenance check at each visit of the service staff. Inspect the radio for mechanical damages, salt deposits, corrosion and any foreign material. Due to its robust construction and ruggedness the radio has a long lifetime. Anyway it must carefully be checked at intervals not longer than 12 months - dependent on the current working conditions.

## Salt deposits

Antenna system, including Antenna Tuning Unit, whip antenna, feeder wire and especially supporting isolators should be checked regularly and kept clean to avoid flash-overs and reduced output power causing poor radiation.

In case the indoor equipment has been exposed to sea water there is a risk of salt crystallization on the keyboard, knobs and cable connectors on the control unit, as well as on cable connectors on the transceiver unit, and they may become inoperable.

Clean the MF/HF radio system with fresh water.

## Weekly installation check

Go through the following weekly check procedure:

1. Select a SSB channel or frequency pair, press PTT and check that tune is done successfully.
2. If a GNSS source is connected, check the position and time in the MF/HF display.
3. Send a DSC test call to an appropriate coast station or ship.
4. Enter Setup, Diagnostics, Self Test and start the applicable test, noting that RF-power will be present during testing. Note that output power is above 60W.

## DSC self test

To run a loop back DSC self test, do as follows:

1. Press the soft key **SETUP**. If it is not in the display, press the soft key **MORE** until **SETUP** appears.
2. Press the arrow soft key **▶** or **◀** to advance to **DSC SETUP**.
3. Turn the selector knob to select **DSC Self Test**. Press and turn the selector knob to select **RUN**.

The test will check the ability to encode/decode DSC signaling on RF level. The radio will automatically transmit a DSC safety test call to its own MMSI number without enabling the transmitter power amplifier. In parallel the radio decodes and compares the received call to be the same as the transmitted.

The display shows the result of the test.

4. Press the soft key **OK** to acknowledge the test result and resume normal operation.

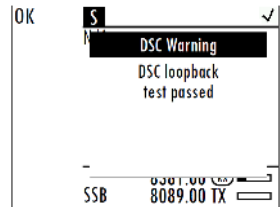

### Important

If the DSC loopback test fails, this indicates the DSC functionality does not work correctly — including the ability to send or receive a Distress message.

Contact your dealer immediately for further advice.

### Note

The Cobham Test station can be called if physical location and weather permits.

Select soft-key Call. Change Type to Safety Test. Input MMSI: 219015591, select appropriate band and press soft-key Send.

The test station is a scanning type and may be busy replying on another band. Retransmit the message if not answered in 60 seconds.

## Temperature specifications

Normal operating temperature: 0°C to +40°C

Extreme operating temperature: -15°C to +55°C

## Troubleshooting

Action	Symptom	Remedy
GNSS	Position source used is different from the expected	<p>If position input source is set to <b>Automatic</b> position (see System Setup) sentences from the following talkers GP, GL, GN (and GA) are prioritized.</p> <p>Position source is selected by the quality indicator:</p> <ol style="list-style-type: none"> <li>1. Differential</li> <li>2. Precise, Autonomous, Float_RTK, Realtime_RTK</li> <li>3. Estimated and Manual</li> <li>4. Unknown (for instance if not supported in sentence)</li> <li>5. Simulated and Invalid</li> </ol> <p>On equal priority the following port order is used:</p> <ol style="list-style-type: none"> <li>1. NMEA TU</li> <li>2. NMEA CU (valid input is always autonomous quality)</li> <li>3. LWE1</li> <li>4. LWE2</li> <li>5. LWE3</li> <li>6. INM-C</li> </ol> <p>The device will automatically switch to the position source with the highest priority available after 5 seconds when switching to a lower priority input and 30 seconds when switching to a detected higher priority input.</p>

Action	Symptom	Remedy
GNSS	Position source selected via LAN is different from the expected	<p>Automatic discovery and selection of up to three (LWE1, LWE2 and LWE3) GNSS source inputs are supported via SLP.</p> <p>If any of the LWE source inputs are manually programmed in System Setup, this will be excluded from automatic discovery.</p> <p>Available source inputs will discover and use the LWE sources with the most important role (primary, secondary, ...)</p>
System Time & Date	Manually entered time & date is overwritten	If valid time information is received via NMEA on any input port, this time source is used to set the system time.

# Alerts in the Bridge Alert Management (BAM) system

## Introduction to alerts

The SAILOR 6300 MF/HF DSC reports alerts of the type warning and caution, and complies with the requirements for Bridge Alert Management according to IEC-62923-1 (2018) and IEC-62923-2 (2018-8).

**Note** Alerts in the Bridge Alert Management system are ship-internal alerts from connected equipment to the bridge.

Alerts are reported and indicated in the top right corner of the SAILOR 6301 Control Unit display.

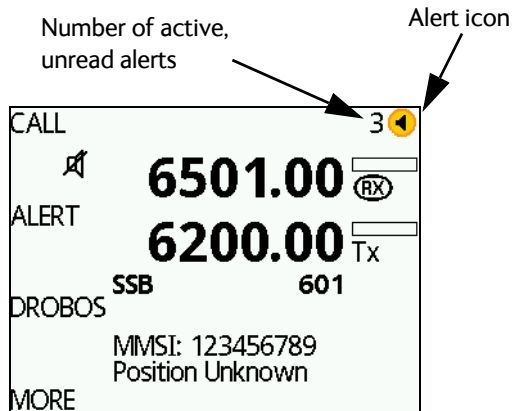

Figure 1: Icons for alerts

An alert is presented with an alert icon in the upper right side of the display. An alert can be of the type warning or caution. If a warning is not acknowledged, the audible warning signal (2 beeps) is repeated every 4 minutes until it is acknowledged. The audible warning signal disappears when the alert changes state from the initial active unacknowledged state, e.g. when it is acknowledged or the alert is rectified.





You can display the current list of active alerts by pushing and holding the Mode/BAM button.





The alert list is prioritized. The most important alert is warning and then caution. The most important active alerts move to the top of the list. Alerts with the same priority/state importance are sorted primarily by time of last change of state (see IEC62923-1 2018 section 6.4.2.1).

## Icons for alerts

The following table shows the icons for alerts with a description.

Icon	Name	Icon description
	Warning: Active unacknowledged alert	<p>A flashing yellow circle with a symbol of a loudspeaker in the middle of the circle. This alert is accompanied by an audible warning signal (2 beeps).</p> <p>This icon is displayed when there is an active unacknowledged warning.</p>
	Warning: Active unacknowledged alert, silent	<p>A flashing yellow circle. A symbol of a loudspeaker with a prominent diagonal line through it.</p> <p>This icon is displayed when there is an active silenced warning.</p>
	Warning: Active acknowledged alert	<p>A yellow circle with an exclamation mark in the middle of the circle.</p> <p>This icon is displayed as long as the warning condition is present.</p>
	Warning: Active transferred alert	<p>A yellow circle. An arrow pointing towards the right in the middle of the circle.</p> <p>This icon is displayed as long as the warning condition is present.</p>

Icon	Name	Icon description
 	Warning: Inactive unacknowledged alert, rectified	<p>A flashing yellow circle with a tick mark in the middle of the circle.</p> <p>This icon is displayed when the warning condition has been rectified but not yet acknowledged.</p>
	Caution: Alert	<p>A yellow square with an exclamation mark in the middle of the square.</p> <p>A caution alert disappears automatically when the caution situation is cleared.</p>

## Alert acknowledgment



Active warnings must be acknowledged. When all active warnings are acknowledged the icons stop flashing. To acknowledge an alert do as follows:

1. Push the Mode/BAM button on the Control Unit to display the list with alerts.  
The counter next to the alert icon counts down for every alert you access.



Counter (number of unread active alerts) →

EXIT Alert list 1/3 2 

  AC Power Outage  
AC power outage has occurred

▶

◀

---

6501.00 

SSB 6200.00 TX

ACK

Acknowledge →

- If it is a DSC related warning, select **Silent** at the DSC popup. This will acknowledge the BAM alert in the list.

**Important**

This is **not** a DSC acknowledgement - it is strictly an acknowledgement of the related BAM alert.

- If it is a non-DSC warning alert, select **ACK** to acknowledge the alert. The alert icon changes into the acknowledged version  and stops flashing.
- Caution alerts do not need to be acknowledged. When they are rectified they automatically disappear from the list.
- Move back and forth in the list with the arrow soft key ◀ or ▶. The text at the top shows the number in the list and the total number of alerts in the list (1/3 in the example above: This is the highest priority alert in the list (1) and there are 3 active alerts in the list).

## List of BAM alerts

The list below shows the alerts that may appear in the display.

**Responsibility transfer:** The SAILOR 6300 MF/HF DSC accepts responsibility transfer requests for all category B Warnings.

**Escalation time:** All Warnings are escalated as Warning after 4 minutes.

ID/Instance	Priority	Category	Title	Description	Reasons and remedy
3022/1	W	B	ACPower Outage	AC power outage has occurred.	Check AC power distribution.
3022/2	W	B	AC_ALR TU	AC power outage has occurred.	No AC power to the Transceiver Unit. Check AC power distribution.

ID/In-stance	Prio-ri-ty	Cate-gory	Title	Description	Reasons and remedy
3023/1	C	B	PS COMM Lost	Powersupply communicati on lost.	Check LAN-cable to SAILOR 6081 Power Supply Unit and Charger. No communication with the power supply.
3023/2	C	B	BATT VOLT Low	Battery and charger. Voltage below limit.	The battery voltage is below the limit.configured for the SAILOR 6081 Power Supply Unit and Charger.
3023/3	C	B	BATT VOLT High	Battery and charger. Voltage above limit.	The battery voltage is above the limit.configured for the SAILOR 6081 Power Supply Unit and Charger.
3023/4	C	B	Supply VOLT Low	Supply voltage too low.	The supply voltage is too low for the SAILOR 6300 MF/HF DSC. Check the power supply and make sure the power supply matches the input voltage specifications stated in the installation manual for the SAILOR 6300 MF/HF DSC. .
3023/5	C	B	Supply VOLT High	Supply voltage too high.	The supply voltage is too high for the SAILOR 6300 MF/HF DSC. Check the power supply and make sure the power supply matches the input voltage specifications stated in the installation manual for the SAILOR 6300 MF/HF DSC.
3078/1	W	B	Printer Status	No connection to printer.	Check the printer. Printer is not connected.

ID/In-stance	Prio-ri-ty	Cate-gory	Title	Description	Reasons and remedy
3016/1	C	B	POSITIO N: LOST	No position available.	The SAILOR 6300 MF/HF DSC is configured to have a position source, but no position information is available. Check your position source. If there is no information from the position source, you can enter a manual position in the SAILOR 6301 Control Unit for temporary use, see <i>Entering the vessel's position manually</i> on page 14.
3016/2	C	B	POSITIO N: LOST	No position available for 10 minutes.	The SAILOR 6300 MF/HF DSC has previously received position info from the position source, but has lost the position input. Check your position source. If there is no information from the position source, you can enter a manual position in the SAILOR 6301 Control Unit for temporary use, see <i>Entering the vessel's position manually</i> on page 14.
3122 <sup>a</sup>	W	A	DISTRES S:RX	Incoming distress	An incoming DSC distress is received. This alert stays active (in the list of alerts) until the DSC distress session has ended. <sup>b</sup>
3122 <sup>a</sup>	W	A	DISTRES S: RELAY	Incoming distress relay	An incoming relayed DSC distress is received. This alert stays active (in the list of alerts) until the DSC distress session has ended. <sup>b</sup>
3122 <sup>a</sup>	W	A	URGENC Y:RX	Incoming urgency call	An incoming DSC urgency call is received. This alert stays active (in the list of alerts) until the DSC urgency session has ended. <sup>b</sup>

ID/In-stance	Prio-ri-ty	Cate-gory	Title	Description	Reasons and remedy
3123 <sup>a</sup>	C	B	SAFETY: COM	Incoming safety call	An incoming DSC safety call is received. The alert is cleared and removed from the alert list when you have selected it from the SAILOR 6301 Control Unit or answered the call, or when a timeout period has expired. <sup>b</sup>
3123 <sup>a</sup>	C	B	SAFETY: POS	Incoming safety pos. call	An incoming DSC safety position call is received. The alert is cleared and removed from the alert list when you have selected it from the SAILOR 6301 Control Unit or answered the call, or when a timeout period has expired. <sup>b</sup>
3123/ <sup>a</sup>	C	B	SAFETY: TEST	Incoming safety test call	An incoming DSC safety test call is received. The alert is cleared and removed from the alert list when you have selected it from the SAILOR 6301 Control Unit or answered the call, or when a timeout period has expired. <sup>b</sup>
3123/ <sup>a</sup>	C	B	ROUTINE : COM	Incoming routine call	An incoming DSC routine call is received. The alert is cleared and removed from the alert list when you have selected it from the SAILOR 6301 Control Unit or answered the call, or when a timeout period has expired. <sup>b</sup>
3123/ <sup>a</sup>	C	B	ROUTINE : POLL	Incoming routine poll	An incoming DSC routine poll is received. The alert is cleared and removed from the alert list when you have selected it from the SAILOR 6301 Control Unit , or when a timeout period has expired. <sup>b</sup>

ID/Instance	Priority	Category	Title	Description	Reasons and remedy
3123/ <sup>a</sup>	C	B	GROUP: RX	Incoming group call	An incoming DSC group call is received. The alert is cleared and removed from the alert list when you have selected it from the SAILOR 6301 Control Unit or answered the call, or when a timeout period has expired. <sup>b</sup>
3008/1	W	B	TX POWER: INHIBIT	Transmission inhibited at MFHF TU	Transmission is inhibited at the Transceiver Unit. This means that calls made from the MF/HF radio will <b>not</b> be transmitted.
3115/1	W	B	ANTENN A: TUNER	ATU not responding. Verify connection	The Antenna Tuner Unit (ATU) is not responding. Check the connection between the MF/HF radio and the ATU.

- a. Dynamic - Alert instance is assigned dynamically. This way there can be more active alerts of the same ID and title at the same time, as they will be assigned different instance numbers.
- b. See *DSC setup* on page 44 for details on how to configure the timeout for different types of calls.

# Diagnostics

## Diagnostics

In the Diagnostics menu in SETUP the following submenus are available:

- *Log with system status messages*
- *Self Test*
- *ATU status*

### Log with system status messages

In the Log menu you can view the system status, with time, date and a description (besides a technician code). The system status is not an error log. It is a log with issues logged by the radio during normal use.

**Example:** Bad SWR, which may occur in poor installations, hard weather making the transmitter antenna sway, etc.

To view system messages, do as follows:

1. Press the soft key **SETUP**. If it is not in the display, press the soft key **MORE** until **SETUP** appears.
2. Press the arrow soft key **▶** or **◀** to advance to and select **Diagnostics** and then **Log**.
3. Turn the selector knob to go to a setting, then press the selector knob to view the system setting.
4. Press **EXIT** to return to normal radio operation.

**Note**

If the message **ATU: No Comm.** appears in the display during normal use, this might be a temporary condition depending on the current installation. If the problem persists, a pop-up message with an error message appears in the display.



Most of the messages are marked as TU (transceiver unit) or ATU (Antenna Tuning Unit) messages.

Text in the display	Explanation	Possible cause(s)
Low Tune Power	Too little power reaches the antenna tuner to tune properly.	Poor antenna installation or cable
High Tune Power	Too much power reaches the antenna tuner.	Standing waves may be present
TU: Power Low	Too low power compared to expected.	Poor installation or too short antenna, etc.
TU: Power High	Too high power output from transceiver unit.	Defective power loop, transmitting single tone, etc
TU: High Low-Power	Low power mode transmits with more power than expected.	Reflections on cable or standing waves, etc.
TU: High Temp	Transmitter overheating.	Poor ventilation. Very hot ambient temperature or prolonged transmission.
TU: High SWR*	Transmitter sees a high Standing Wave Ratio (SWR).	Poor antenna, cable, fittings or grounding of the installation. Can temporarily occur if ice or water is present on the antenna or during tuning or in rough sea and wind.
TU: Low Power	Transmitter reduced power.	Protection due to overheating or prolonged transmission
TU: TX Inhib.	Transmission inhibited.	TX_INHIBIT switch is set or a severe protection of the transmitter has set in

Text in the display	Explanation	Possible cause(s)
TU: LO Error	Local Oscillator is not within valid range.	Local Oscillator not locked
ATU: Not Tuned	ATU did not find a proper matching to the antenna resulting in less power out.	Poor antenna connection grounding etc.
ATU: No Tune Power	Too little power present at ATU to tune properly.	Too long antenna cable or too much loss in the antenna cable
ATU: High U/I*	High current or voltage present at ATU causing reduced power output.	Too short antenna and or feed wire or poor matching by ATU
ATU: High Temp*	High Temperature inside ATU.	Prolonged transmission or bad SWR match
ATU: Bad SWR*	ATU measures SWR > 8.	Bad antenna installation or standing waves
ATU: High SWR*	ATU measures high SWR.	Bad antenna installation or temporarily bad SWR due to weather or sea etc.
ATU: No Comm.	ATU does not communicate properly.	Very long antenna cable of wrong dimension, or ATU defective. This can also occur temporarily when turning on the radio, until the ATU is ready.

\* Marked log entries are not necessarily an error but will reduce output power to protect the equipment.

## Self Test

Two different self tests are available:

- Tx single-band transmission test
- Tx multi-band transmission test

The Tx single Band test performs a tone transmitter test on the current TX frequency shown in the display.

**Note**

This test transmits a short test signal at full power — the radio operator needs to verify that the channel is free from any traffic before starting the test!

The output of this test is the transmitted power and the battery voltage. Note that the output power is not calibrated, so the power figure may only be used as a guideline. The battery voltage should not drop significantly during this test, as this indicates a poor installation (e.g. thin wires, etc.)

The Tx Multi Band test is similar to the single band test. However, this test automatically transmits on the channel **next to** all six distress SSB frequencies:

- 2182+3 kHz
- 4125+3 kHz
- 6215+3 kHz
- 8291+3 kHz
- 12290+3 kHz
- 16420+3 kHz

If you exit the test before it is finished, a system status message will not be added to the diagnostics log.

## ATU status

In the ATU status menu the following items are present:

- ATU software version
- ATU Selftest response in the format 0x00. This code should be mentioned if any service inquiries regarding output power or antenna tuner are made

- ATU SWR ratio. For the tuner, the standing wave ratio of last tune session is recorded.
- ATU TX Relays. For the tuner, the actual settings of relays in the different banks of the tuner are shown. This information can be used when making technical inquiries regarding power and tuning.

## Warranty and returning units for repair

Should your Cobham SATCOM product fail, please contact your dealer or installer, or the nearest Cobham SATCOM partner. You will find the partner details on [www.cobham.com/satcom](http://www.cobham.com/satcom) where you also find the Cobham SATCOM Self Service Center web-portal, which may help you solve the problem.

Your dealer, installer or Cobham SATCOM partner will assist you whether the need is user training, technical support, arranging on-site repair or sending the product for repair.

Your dealer, installer or Cobham SATCOM partner will also take care of any warranty issue.

## Repacking for shipment

Should you need to send the product for repair, please read the below information before packing the product.

The shipping carton has been carefully designed to protect the SAILOR 6300 MF/HF DSC and its accessories during shipment. This carton and its associated packing material should be used when repacking for shipment. Attach a tag indicating the type of service required, return address, part number and full serial number. Mark the carton FRAGILE to ensure careful handling.

**Note** | Correct shipment is the customer's own responsibility.

If the original shipping carton is not available, the following general instructions should be used for repacking with commercially available material.

1. Wrap the defective unit in heavy paper or plastic. Attach a tag indicating the type of service required, return address, part number and full serial number.
2. Use a strong shipping container, e.g. a double walled carton.
3. Protect the front- and rear panel with cardboard and insert a layer of shock-absorbing material between all surfaces of the equipment and the sides of the container.
4. Seal the shipping container securely.
5. Mark the shipping container FRAGILE to ensure careful handling.

Failure to do so may invalidate the warranty.



## A

AM Amplitude Modulation

## B

BAM Bridge Alert Management (BAM) is a concept, defined by the IMO, for the management, handling and harmonized presentation of alerts on the bridge.

## D

DROBOS Distress Relay On Behalf Of Someone else

DSC Digital Selective Calling

## F

FEC Forward Error Correction. A system of error control for data transmission, whereby the sender adds redundant data to its messages, also known as an error-correcting code

## G

GMDSS Global Maritime Distress and Safety System

GNSS Global Navigation Satellite System

GPL General Public License, Software license, which guarantees individuals, organizations and companies the freedom to use, study, share (copy), and modify the software.

GPS Global Positioning System

## **H**

HF High Frequency

## **I**

ITU International Telecommunications Union

## **L**

LGPL Lesser General Public License

## **M**

MF Medium Frequency

MMSI Maritime Mobile Ship Identification

## **S**

SSB Single Side Band

SWR Standing Wave Ratio

## **T**

TFT Thin Film Transistor. Type of liquid crystal display.

TU Transceiver Unit

## **U**

UTC Coordinated Universal Time defined by ITU



**A**

- accessories, 6
- acknowledgment
  - BAM alerts, 60
  - Distress, 23
- action line, display, 5
- activate
  - scan resume, 43
  - scanning, 20
  - watch, 19
- ACTIVE
  - activate call, 36
  - session, 31
- ADD, 38
- add a contact, 38
- adjust
  - RF gain, 12
  - speaker volume, 10
- alarm, 58
- alarm panel
  - Distress, 25
- ALERT, 23
- alerts
  - acknowledgment of BAM alerts, 60
  - icons for BAM, 59
  - introduction to BAM, 58
  - list of BAM alerts, 61
- Alerts in BAM, 58
- AM BROADCAST, 11
- antenna unit
  - tuning, 10
- area calls, 37
- ATIS code
  - change, 48
- Auto-Ack
  - Individual, 45
  - Test, 44

**B**

- background sessions
  - DSC, 36
- backlight
  - dim, 11
- BAM alerts
  - access list, 60
  - acknowledgment, 60
  - icons, 59
  - introduction, 58
  - list of, 61
- Bridge Alert Management, 58
- browse channels, 11
- buttons
  - description, 4

**C**

- CALL, 38
- call
  - activate, 36
  - Distress procedure, vi
  - DSC, 21
  - end, 15
  - hold, 36
  - quick guide, 17
  - routine, 32
  - safety, 32
  - update, 31
  - urgency, 32
  - voice, non-DSC, 32
- call log, DSC, 46
- canceling
  - Distress, 24

- channel
  - add to scan, 20
  - information, 15
  - remove from scan, 20
  - select, 11
- check
  - installation, 54
- clear
  - position data, 14
- color theme, 47
- Comm Inactivity, 45
- contact, 53
  - adding, 38
  - deleting, 39
  - editing, 39
  - sorting, 38
- controls, front plate, 4
- cradle for 6201, installation, 6

## D

- deactivate
  - watch, 19
- default reset, 48
- DELETE, 40
- delete contact, 39
- diagnostics, 50, 66
- dim, 11
- display, 5
- display color
  - change, 16, 47

- Distress, 26
  - acknowledgment, 23
  - canceling, 24
  - power failure, 25
  - received calls, 27
  - relaying for someone else, 26
  - send from alarm panel, 25
  - sending, 22
  - with specified parameters, 23
- Distress button, 22
- Distress procedure, vi
- Distress timeout, 45
- document number, this manual, i
- DROBOS, 26
- DSC, 11

- background sessions, 36
- call log, 28, 46
- calls, 21
- loopback test, 55
- making a call, 28
- multiple calls, 36
- self test, 54
- session definition, 31
- setup, 44
- DSC alarms
  - non distress, 45
- DSC message
  - print, 30, 46
- DSC session, 31
  - typical display, 31
- DSC soft keys, 33
- DSC window, 31

## E

- editing a contact, 39
- emergency calls, vi

end  
  session, 15  
end call, 15  
engagement status, 15  
enter position manually, 14

## F

factory defaults, 48  
FCC approved equipment  
  training information, viii  
features, 2  
FILTER, 20  
filter  
  phone book, 38  
frequencies  
  simplex, entering, 12  
frequencies, entering, 11  
front plate, controls, 4

## G

geographical area calls, 37  
GPS data, 14  
GPS position  
  display, 14

## H

handset cradle  
  installation, 6  
hang time, 43  
HOLD  
  holding a call, 36  
  session, 31

## I

icons  
  session state, 31  
icons for BAM alerts, 59  
installation  
  cradle for 6201, 6  
  handset cradle, 6  
installation check, 54  
IP address  
  Control Unit, 49  
  Transceiver Unit, 48

## K

keys on front plate, 4  
knob  
  selector, 4  
  volume, 4

## L

lock  
  keys, 49  
log, 50  
louder, volume, 10

## M

maintenance, 53  
manual, document number, i  
MAYDAY, vi  
medical transport, 45  
menus  
  overview, 51  
  soft key functions, 13  
message  
  replay, 41

- messages
  - ATU, 67
  - TU, 67
- MF/HF DSC
  - description, 1
- MMSI
  - change, 48
- mode
  - AM BROADCAST, 11
  - DSC, 11
  - select, 11
  - SSB, 11
  - SSB(EXT.), 11
  - TELEX, 11
- monitor power supply, 44
- MORE, 13
- multi-band transmission test, 69
- multiple calls, DSC, 36
- mute
  - speaker, 12

## N

- neutral crafts, 45
- night vision, how to dim, 11
- Non-dist Inactivity, 45
- Non-distr.alarms, 45

## P

- password, 48
- PHBOOK, 38
- phone book, 38
  - add contact, 38
  - delete a contact, 39
  - edit a contact, 39
  - sorting, 38

- position
  - clear, 14
  - enter manually, 14
- position data
  - enter manually, 44
- position Info, 44
- position information, 14
- power
  - off, 10
  - on, 10
- power failure
  - Distress, 25
- power supply
  - monitor, 44
- print
  - DSC message, 30, 46
- printer
  - DSC messages, 46
  - setup, default, 30
  - supported, 46
- Printer Config, 30
- PTT button, 18

## Q

- QUIT, 15

## R

- radio call
  - making, 18
  - receiving, 17
- radiotelex, 40
- received Distress calls, 27
- repacking for shipment, 71
- repair, 70

---

replay, 41  
  button, 4  
  rewind, 41  
  stop, 41  
reset to default, 48  
resume time, 43  
returning units, 70  
RF exposure hazards, v  
RF gain, 12  
routine call, 32

## S

safety call, 32  
safety summary, iv  
salt deposits, 53  
scan  
  add channel, 20  
  hang time, 43  
  mode, 43  
  multi, 43  
  remove channel, 20  
  resume time, 43  
  resume, activate, 43  
  SSB voice, 13, 43  
  start, 20  
selector knob, 4, 11  
self test, 54, 66  
  multi-band, 69  
  single band, 69  
self test, DSC, 54  
serial number  
  Control Unit, 49  
  Transceiver Unit, 48  
service line, display, 5  
service procedure  
  weekly, 54  
session  
  ACTIVE, 31  
  HOLD, 31  
  INFO key, 35  
  line, 32  
  soft keys, 33  
  state icons, 31  
  status, 33  
  what is, 31  
setup  
  controller, 49  
  printer, 30  
  Radio, 43  
  system, 46  
  watch, 43  
setup pages overview, 51  
shipment  
  packing instructions, 71  
simplex frequencies  
  enter, 12  
single-band transmission test, 69  
soft key, 13  
  ADD, 38  
  CALL, 38  
  DELETE, 40  
  DISACK, 27  
  DSC, 33  
  FILTER, 20  
  MORE, 13  
  PHBOOK, 38  
  RELAY, 26  
  STOP, 41  
  TAG, 20  
  WATCH, 19  
soft keys, 13  
  overview, 51  
softer, volume, 10

- software version
    - Control Unit, 49
    - Transceiver unit, 48
  - sorting contacts, 38
  - speaker volume, 10
  - specifications
    - temperature, operating, 55
  - squelch
    - control, 4
    - on, off, 16
  - SSB, 11
  - SSB (EXT.), 11
  - SSB voice
    - scan, 13, 43
  - STOP, 41
  - stop
    - replaying a message, 41
    - watch or scan, 19, 20
  - subcommunication
    - mode, 23
    - telex, 23
    - voice, 23
  - support, 53
  - SW version, 48
  - system configuration example, 8
  - system messages, 50
  - system overview, 3
  - system setup, 46
- T**
- TAG, 20
    - remove, 20
  - tagged channels
    - view, 20
  - TELEX, 11
  - telex, 40
    - subcommunication, 23
  - temperature
    - operating, 55
  - terminate
    - call, 15
    - engagement, 15
  - test
    - multi-band, 69
    - single band, 69
  - theme
    - color, change, 47
  - timeout, 47
    - Distress, 45
    - non distress, 45
    - VHF and other non distress, 45
  - troubleshooting, 66
  - tuning
    - antenna unit, 10
  - TX inhibit, 18
- U**
- urgency call, 32
  - Use GPS, 14
  - UTC time, 5
    - enter manually, 14
- V**
- variants, 3
  - voice
    - call, 32
    - subcommunication, 23
  - voice scan, 43
  - volume
    - louder, 10
    - softer, 10
    - speaker, 10
  - Volume knob, 4

**W**

warranty, iii, 70

    limitation, v

WATCH, 13, 19, 20

watch

    setup, 43

    start, 19

    stop, 19

weekly check, 54







