



INSTRUCTION MANUAL

VHF MARINE TRANSCEIVERS

**IC-M220**  
**IC-M220G**



Thank you for choosing this Icom product. This product is designed and built with Icom's state of the art technology and craftsmanship. With proper care, this product should provide you with years of trouble-free operation.

## ■ IMPORTANT

**READ ALL INSTRUCTIONS** carefully and completely before using the transceiver.

**SAVE THIS INSTRUCTION MANUAL** — This instruction manual contains important operating instructions for the IC-M220, IC-M220G.

This instruction manual includes some functions that are usable only when they are preset by your dealer. Ask your dealer for details.

## ■ EXPLICIT DEFINITIONS

WORD	DEFINITION
<b>⚠WARNING!</b>	Personal injury, fire hazard or electric shock may occur.
<b>CAUTION</b>	Equipment damage may occur.
<b>NOTE</b>	If disregarded, inconvenience only. No risk of personal injury, fire or electric shock.

Icom is not responsible for the destruction, damage to, or performance of any Icom or non-Icom equipment, if the malfunction is because of:

- Force majeure, including, but not limited to, fires, earthquakes, storms, floods, lightning, other natural disasters, disturbances, riots, war, or radioactive contamination.
- The use of Icom transceivers with any equipment that is not manufactured or approved by Icom.

## ■ FEATURES

- Flexible installation with a compact body
- Easy user interface  
The transceiver is equipped with a screen for easy readability and easy-to-use user interface.
- Dualwatch and Tri-watch functions  
Convenient functions that enable you to monitor the Distress channel (Ch 16) while receiving on another channel (Dualwatch), or while receiving on another channel, and the Call channel (Tri-watch).
- Built-in Class D DSC function  
The transceiver has the DSC functions for distress alert transmission and reception, as well as the general DSC calls such as Individual calls, All ships calls, Group calls, and so on.
- Built-in GPS receiver (For only the IC-M220G)

Icom, Icom Inc. and the Icom logo are registered trademarks of Icom Incorporated (Japan) in Japan, the United States, the United Kingdom, Germany, France, Spain, Russia, Australia, New Zealand, and/or other countries. AquaQuake is a trademark of Icom Incorporated. All other products or brands are registered trademarks or trademarks of their respective holders.

---

## ■ IN CASE OF EMERGENCY

If your vessel requires assistance, contact other vessels and the Coast Guard by sending a distress call on Channel 16, or, transmit your Distress call using Digital Selective Calling (DSC) on Channel 70.

### ◇ USING CHANNEL 16

1. Push [16/C] to switch to Channel 16.
2. While holding down [PTT], give the appropriate information as follows:

- “**MAYDAY MAYDAY MAYDAY.**”
- “**THIS IS** [ ]” (name of vessel).
- Say your call sign or other indication of the vessel (AND your 9 digit DSC ID, if you have one).
- “**LOCATED AT** [ ]” (your position).
- State the nature of the distress and assistance required.
- Give any other information which might facilitate the rescue.

### ◇ USING DIGITAL SELECTIVE CALLING

1. Lift up the key cover, hold down [DISTRESS] for 3 seconds until the 3 short beeps and then one long beep sound.

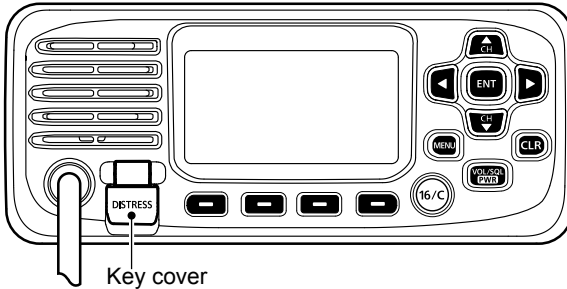

2. Wait for an acknowledgment from another station.
3. After the acknowledgement is received, Channel 16 is automatically selected.
4. Hold down [PTT], then transmit the appropriate information as listed above.

---

## ■ RADIO OPERATION WARNING



**WARNING**

Icom requires the radio operator to meet the FCC Requirements for Radio Frequency Exposure. An omnidirectional antenna with gain not greater than 9 dBi must be mounted a minimum of 5 meters (measured from the lowest point of the antenna) vertically above the main deck and all possible personnel. This is the minimum safe separation distance estimated to meet all RF exposure compliance requirements. This 5 meter distance is based on the FCC Safe Maximum Permissible Exposure (MPE) distance of 3 meters added to the height of an adult (2 meters) and is appropriate for all vessels.

For watercraft without suitable structures, the antenna must be mounted so as to maintain a minimum of 1 meter vertically between the antenna, (measured from the lowest point of the antenna), to the heads of all persons AND all persons must stay outside of the 3 meter MPE radius.

Do not transmit with radio and antenna when persons are within the MPE radius of the antenna, unless such persons (such as driver or radio operator) are shielded from antenna field by a grounded metallic barrier. The MPE Radius is the minimum distance from the antenna axis that person should maintain in order to avoid RF exposure higher than the allowable MPE level set by FCC.

**FAILURE TO OBSERVE THESE LIMITS MAY ALLOW THOSE WITHIN THE MPE RADIUS TO EXPERIENCE RF RADIATION ABSORPTION WHICH EXCEEDS THE FCC MAXIMUM PERMISSIBLE EXPOSURE (MPE) LIMIT.**

**IT IS THE RESPONSIBILITY OF THE RADIO OPERATOR TO ENSURE THAT THE MAXIMUM PERMISSIBLE EXPOSURE LIMITS ARE OBSERVED AT ALL TIMES DURING RADIO TRANSMISSION. THE RADIO OPERATOR IS TO ENSURE THAT NO BYSTANDERS COME WITHIN THE RADIUS OF THE MAXIMUM PERMISSIBLE EXPOSURE LIMITS.**

### **Determining MPE Radius**

**THE MAXIMUM PERMISSIBLE EXPOSURE (MPE) RADIUS HAS BEEN ESTIMATED TO BE A RADIUS OF ABOUT 3M PER OET BULLETIN 65 OF THE FCC.**

**THIS ESTIMATE IS MADE ASSUMING THE MAXIMUM POWER OF THE RADIO AND ANTENNAS WITH A MAXIMUM GAIN OF 9dBi ARE USED FOR A SHIP MOUNTED SYSTEM.**



---

## ■ AVERTISSEMENT POUR LES OPÉRATEURS RADIO



### AVERTISSEMENT

Icom exige que l'opérateur radio se conforme aux exigences de la FCC en matière d'exposition aux radiofréquences. Une antenne omnidirectionnelle dont le gain ne dépasse pas 9dBi doit être fixée à une distance minimale de 5 mètres (mesurée depuis le point le plus bas de l'antenne) verticalement au-dessus du pont principal et de tout le personnel qui peut s'y trouver. Il s'agit de la distance de sécurité minimale prévue pour satisfaire aux exigences de conformité en matière d'exposition aux RF. Cette distance de 5 mètres est établie en fonction de l'exposition maximale admissible sécuritaire de 3 mètres établie par la FCC, à laquelle on ajoute la hauteur d'un adulte (2 mètres); cette distance convient pour tous les navires.

Dans le cas des embarcations sans structure convenable, l'antenne doit être fixée de façon à maintenir une distance minimale de 1 mètre verticalement entre cette antenne (mesurée depuis son point le plus bas) et la tête de toute personne présente; toutes les personnes présentes doivent se tenir à l'extérieur d'un rayon d'exposition maximale admissible de 3 mètres.

Ne pas émettre à l'aide de la radio et de l'antenne lorsque des personnes se trouvent à l'intérieur du rayon d'exposition maximale admissible de cette antenne, à moins que ces personnes (comme le conducteur ou l'opérateur radio) ne soient protégées du champ de l'antenne par un écran métallique relié à la masse. Le rayon d'exposition maximale admissible équivaut à la distance minimale que cette personne doit maintenir entre elle et l'axe de l'antenne pour éviter une exposition aux RF supérieure au niveau d'exposition maximale admissible fixé par la FCC.

**LE NON-RESPECT DE CES LIMITES PEUT CAUSER, POUR LES PERSONNES SITUÉES DANS LE RAYON D'EXPOSITION MAXIMALE ADMISSIBLE, UNE ABSORPTION DE RAYONNEMENT DE RF SUPÉRIEURE À L'EXPOSITION MAXIMALE ADMISSIBLE FIXÉE PAR LA FCC.**

**L'OPÉRATEUR RADIO EST RESPONSABLE D'ASSURER QUE LES LIMITES D'EXPOSITION MAXIMALE ADMISSIBLE SOIENT RESPECTÉES EN TOUT TEMPS PENDANT LA TRANSMISSION RADIO. L'OPÉRATEUR RADIO DOIT S'ASSURER QU'AUCUNE PERSONNE PRÉSENTE NE SE SITUE À L'INTÉRIEUR DU RAYON D'EXPOSITION MAXIMALE ADMISSIBLE.**

**Établir le rayon d'exposition maximale admissible  
ON ESTIME QUE LE RAYON D'EXPOSITION MAXIMALE ADMISSIBLE EST D'ENVIRON 3 M, TEL QUE STIPULÉ DANS LE BULLETIN OET 65 DE LA FCC.  
CETTE DISTANCE ESTIMÉE TIEN COMPTE D'UN SYSTÈME INSTALLÉ SUR UN NAVIRE UTILISANT LA PUISSANCE MAXIMALE DE LA RADIO ET DES ANTENNES DONT LE GAIN MAXIMAL EST DE 9dBi.**

**Determining MPE Radius**

**THE MAXIMUM PERMISSIBLE EXPOSURE (MPE) RADIUS HAS BEEN ESTIMATED TO BE A RADIUS OF ABOUT 3M PER OET BULLETIN 65 OF THE FCC.  
THIS ESTIMATE IS MADE ASSUMING THE MAXIMUM POWER OF THE RADIO AND ANTENNAS WITH A MAXIMUM GAIN OF 9dBi ARE USED FOR A SHIP MOUNTED SYSTEM.**

## ■ FCC INFORMATION

This equipment has been tested and found to comply with the limits for a Class A digital device, pursuant to part 15 of the FCC Rules. These limits are designed to provide reasonable protection against harmful interference when the equipment is operated in a commercial environment. This equipment generates, uses, and can radiate radio frequency energy and, if not installed and used in accordance with the instruction manual, may cause harmful interference to radio communications.

Operation of this equipment in a residential area is likely to cause harmful interference in which case the user will be required to correct the interference at his own expense.

**CAUTION:** Changes or modifications to this transceiver, not expressly approved by Icom Inc., could void your authority to operate this transceiver under FCC regulations.

## ■ INFORMATION FCC

Cet équipement a été testé et reconnu conforme aux limites fixées pour un appareil numérique de classe A, conformément au point 15 de la réglementation FCC. Ces limites sont définies de façon à fournir une protection raisonnable contre le brouillage préjudiciable lorsque cet appareil est utilisé dans un environnement commercial. Cet équipement génère, utilise et peut émettre un rayonnement de fréquence radio. S'il n'a pas été installé conformément aux instructions, il peut par ailleurs créer des interférences perturbant les communications radio.

L'utilisation de cet appareil dans une zone résidentielle peut provoquer un brouillage préjudiciable, auquel cas l'utilisateur sera tenu de corriger la situation à ses frais.

**MISE EN GARDE:** Tout changement ou modification, non expressément approuvé par Icom Inc., peut annuler l'autorisation de l'utilisateur à utiliser cet appareil conformément à la réglementation FCC.

## ■ NOTE

**A WARNING STICKER is supplied with the USA version transceiver.**

To comply with FCC regulations, this sticker must be affixed in such a location as to be readily seen from the operating controls of the radio as in the diagram below. Make sure the chosen location is clean and dry before applying the sticker.



---

## ■ PRECAUTIONS

⚠ **WARNING! NEVER** connect the transceiver directly to an AC outlet. This may cause a fire or an electric shock.

⚠ **WARNING! NEVER** connect the transceiver to a power source of more than 16 V DC such as a 24 V battery. This connection could cause a fire or damage the transceiver.

⚠ **WARNING! NEVER** reverse the DC power cable polarity. This could cause a fire or damage the equipment.

⚠ **WARNING! NEVER** cut the DC power cable between the DC power connector on the transceiver's rear panel and the fuse holder. If an incorrect connection is made after cutting, the transceiver may be damaged.

⚠ **WARNING! NEVER** operate the transceiver during a lightning storm. It may result in an electric shock, cause a fire or damage the transceiver. Always disconnect the power source and antenna before a storm.

⚠ **WARNING! NEVER** place the transceiver where normal operation of the vessel may be hindered, or where it could cause bodily injury.

**CAUTION: DO NOT** place or leave the transceiver in areas with temperatures below  $-20^{\circ}\text{C} \sim +60^{\circ}\text{C}$  ( $-4^{\circ}\text{F} \sim +140^{\circ}\text{F}$ ), or in areas subject to direct sunlight, such as a dashboard.

**CAUTION: DO NOT** use harsh solvents such as Benzine or alcohol when cleaning. This could damage the equipment surfaces. If the surface becomes dusty or dirty, wipe it clean with a soft, dry cloth.

**BE CAREFUL!** The transceiver's rear panel will become hot when transmitting continuously for long periods of time.

**BE CAREFUL!** The transceiver meets IPX7 requirements for waterproof protection\*. However, once the transceiver or microphone has been dropped, or the waterproof seal is cracked or damaged, waterproof protection cannot be guaranteed because of possible damage to the case or the waterproof seal.

\* Except for the DC power connector, NMEA In/Out leads and AF Out leads.

**NOTE:** Install the transceiver and/or microphone more than 1 meter from the vessel's magnetic navigation compass.

**NOTE:** Place the transceiver in a secure place to avoid inadvertent use by unauthorized persons.

---

## ■ PRÉCAUTIONS

⚠ **AVERTISSEMENT ! NE JAMAIS** relier l'émetteur-récepteur à une prise CA. Cela pourrait provoquer un choc électrique ou un incendie.

⚠ **AVERTISSEMENT ! NE JAMAIS** brancher l'émetteur-récepteur sur une source d'alimentation supérieure à 16 V CC, comme une batterie de 24 V. Cela pourrait endommager l'émetteur-récepteur.

⚠ **AVERTISSEMENT ! NE JAMAIS** inverser la polarité du câble d'alimentation CC lors de la connexion à une source d'alimentation. Cela pourrait endommager l'émetteur-récepteur.

⚠ **AVERTISSEMENT ! NE JAMAIS** couper le câble d'alimentation CC entre la prise CC à l'arrière de l'émetteur-récepteur et le porte-fusible. L'émetteur-récepteur peut être endommagé par la suite en cas de connexion inappropriée.

⚠ **AVERTISSEMENT ! NE JAMAIS** utiliser l'émetteur-récepteur durant un orage. Cela risquerait de provoquer un choc électrique, un incendie ou d'endommager l'émetteur-récepteur. Toujours débrancher la source d'alimentation et l'antenne avant une tempête.

⚠ **AVERTISSEMENT ! NE JAMAIS** installer l'émetteur-récepteur à un emplacement où il pourrait gêner le fonctionnement normal du navire ou provoquer des blessures corporelles.

⚠ **MISE EN GARDE : NE PAS** utiliser ou placer l'émetteur-récepteur dans des zones où la température est inférieure à  $-20^{\circ}$  ou supérieure à  $+60^{\circ}$  ou dans des zones soumises au rayonnement solaire direct, telles le tableau de bord.

**MISE EN GARDE : NE PAS** utiliser de dissolvants agressifs tels que du Benzène ou de l'alcool lors du nettoyage, car ils endommageraient les surfaces de l'émetteur-récepteur. Si l'émetteur-récepteur est poussiéreux ou sale, nettoyez-le avec un tissu doux et sec.

**MISE EN GARDE :** La face arrière de la VHF chauffe en cas d'utilisation continue sur une longue durée.

**MISE EN GARDE :** L'émetteur-récepteur est étanche conformément à la norme IPX7\*. L'étanchéité ne peut plus être garantie après une chute de l'appareil en raison des risques de fissures du boîtier, de dégradation du joint d'étanchéité, etc.

\*Les connecteurs sur le panneau arrière ne sont pas étanche IPX7.

**REMARQUE: INSTALLER la VHF** et le microphone à au moins 1 m du compas de route du navire.

**REMARQUE:** Placer l'émetteur-récepteur hors de portée des enfants pour éviter toute utilisation inopinée.

Si la face avant est exposée à de l'eau de mer, **ASSUREZ-VOUS DE LE NETTOYER ENTIEREMENT AVEC DE L'EAU DOUCE** lorsque la protection étanche sur le panneau avant fonctionne. Dans le cas contraire, les touches et le commutateur risquent de ne plus fonctionner en raison de la cristallisation du sel.

---

## ■ RECOMMENDATION

**CLEAN THE TRANSCEIVER AND MICROPHONE THOROUGHLY WITH FRESH WATER** after exposure to saltwater, and dry it before operating. Otherwise, the transceiver's keys, switches and controllers may become unusable, due to salt crystallization.

**NOTE:** If the transceiver's waterproof protection appears defective, carefully clean it with a soft, wet (fresh water) cloth, then, dry it before operating.  
The transceiver may lose its waterproof protection if the case or microphone is cracked or broken, the microphone connector is not screwed in completely, or the transceiver has been dropped.  
Contact your Icom distributor or your dealer for advice.

## ■ KEY ICON DESCRIPTION

The keys are described in this manual as follows:

The keys that have an words or letters on them are described with the characters “[ ]”.

Example: [MENU], [CLR]

The Software Keys are described with the words or letters on a dark background such as **ENT** or **DISTRESS**. The function of the keys are shown at the bottom of the display. Push the key below the desired function.

You can use the following keys on the Menu screen.

FUNCTION	ACTION
Select	Push [▼] or [▲].
Enter	Push [ENT], <b>ENT</b> .
Go to the next tree level	Push [ENT], <b>ENT</b> , or [▶].
Go back to the previous tree level	Push [CLR], <b>BACK</b> , or [◀].
Cancel	Push [CLR].
Exit	Push [MENU] or <b>EXIT</b> .

---

# ■ TABLE OF CONTENTS

■ IMPORTANT .....	ii	<b>7 DIGITAL SELECTIVE CALLING (DSC)</b>	<b>15</b>
■ EXPLICIT DEFINITIONS .....	ii	■ DSC address ID .....	15
■ FEATURES .....	ii	■ Entering the position and time.....	16
■ IN CASE OF EMERGENCY.....	iii	■ Sending DSC calls (Distress).....	17
■ RADIO OPERATION WARNING.....	iv	■ Sending DSC calls (other).....	20
■ AVERTISSEMENT POUR LES OPÉRATEURS RADIO .....	v	■ Receiving DSC calls (Distress) .....	28
■ FCC INFORMATION .....	vi	■ Receiving DSC calls (other).....	29
■ INFORMATION FCC.....	vi	■ DSC Log.....	33
■ NOTE .....	vi	■ Multiple-task mode .....	34
■ PRECAUTIONS .....	vii	■ DSC Settings.....	36
■ PRÉCAUTIONS .....	viii	<b>8 MENU SCREEN .....</b>	<b>38</b>
■ RECOMMENDATION .....	ix	■ Using the Menu screen .....	38
■ KEY ICON DESCRIPTION .....	ix	■ Menu items description .....	40
<b>1 OPERATING RULES .....</b>	<b>1</b>	<b>9 CONNECTIONS AND MAINTENANCE</b>	<b>43</b>
<b>2 PANEL DESCRIPTION .....</b>	<b>2</b>	■ Supplied accessories .....	43
■ Front panel.....	2	■ Connecting the microphone .....	43
■ Function Display.....	3	■ Connections .....	44
■ Software Keys .....	4	■ Connecting to the MA-510TR.....	45
<b>3 PREPARATION .....</b>	<b>6</b>	■ Fuse replacement .....	45
■ Entering the MMSI code.....	6	■ Cleaning.....	45
<b>4 BASIC OPERATION .....</b>	<b>7</b>	■ Mounting the transceiver.....	46
■ Selecting a channel.....	7	■ MBF-5 installation .....	47
■ Weather channels and Weather Alert..	8	<b>10 SPECIFICATIONS AND OPTIONS ...</b>	<b>48</b>
■ Adjusting the volume level .....	9	■ Specifications.....	48
■ Adjusting the squelch level.....	9	■ Options.....	48
■ Adjusting the backlight or the display contrast .....	9	<b>11 TROUBLESHOOTING .....</b>	<b>49</b>
■ Setting the Call channel .....	10	<b>12 CHANNEL LIST .....</b>	<b>50</b>
■ Receiving and transmitting.....	10	<b>13 TEMPLATE.....</b>	<b>51</b>
■ AquaQuake Water Draining function..	11	INDEX.....	53
■ Editing a channel name.....	11		
<b>5 SCAN OPERATION .....</b>	<b>12</b>		
■ Scan types .....	12		
■ Setting Favorite channels.....	13		
■ Starting a scan .....	13		
<b>6 DUALWATCH/TRI-WATCH .....</b>	<b>14</b>		
■ Description .....	14		
■ Operation .....	14		

## ◇ Priorities

- Read all rules and regulations pertaining to priorities and keep an up-to-date copy handy. Safety and distress calls take priority over all others.
- You must monitor Channel 16 when you are not operating on another channel.
- False or fraudulent distress calls are prohibited under law.

## ◇ Privacy

- Information overheard but not intended for you cannot lawfully be used in any way.
- Indecent or profane language is prohibited.

## ◇ Radio licenses

### (1) SHIP STATION LICENSE

You must have a current radio station license before using the transceiver. It is unlawful to operate a ship station which is not licensed.

Inquire through your dealer or the appropriate government agency for a Ship-Radiotelephone license application. This government-issued license states the call sign which is your craft's identification for radio purposes.

### (2) OPERATOR'S LICENSE

A Restricted Radiotelephone Operator Permit is the license most often held by small vessel radio operators when a radio is not required for safety purposes.

The Restricted Radiotelephone Operator Permit must be posted or kept with the operator. Only a licensed radio operator may operate a transceiver.

However, non-licensed individuals may talk over a transceiver if a licensed operator starts, supervises, ends the call and makes the necessary log entries.

A current copy of the applicable government rules and regulations is only required to be on hand for vessels in which a radio telephone is compulsory. However, even if you are not required to have these on hand it is your responsibility to be thoroughly acquainted with all pertinent rules and regulations.

## Front panel

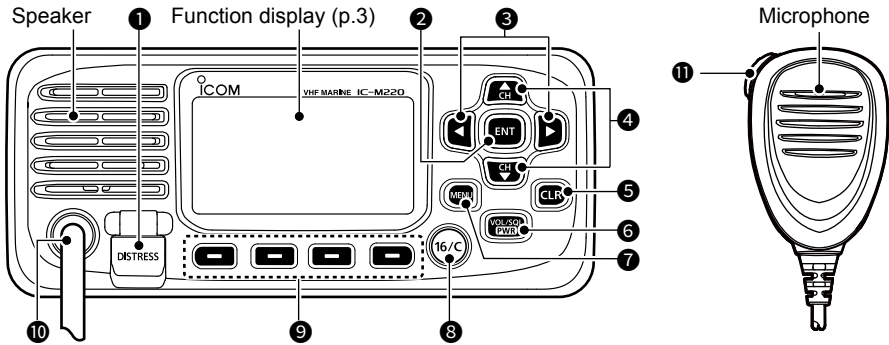

- 1 DISTRESS KEY [DISTRESS]**  
Hold down for 3 seconds to transmit a Distress call.
- 2 ENTER KEY [ENT]**  
Push to set the entered data, selected item, and so on.
- 3 LEFT/RIGHT KEYS [◀]/[▶]**
- Push to scroll the Software Key functions. (pp. 4 ~ 5)
  - Push to select a character or number in the entry mode. (pp. 6, 11, 15~16)
- 4 UP/DOWN KEYS [▲]/[▼]**
- Push to select an operating channel, Menu items, Menu settings, and so on. (p. 7)
  - Push to select a character or number in the entry mode. (pp. 11, 15~16)
- 5 CLEAR KEY [CLR]**  
Push to cancel the entered data, or to return to the previous screen.
- 6 POWER/VOLUME/SQUELCH KEY [PWR/VOL/SQL]**
- Hold down for 1 second to turn the transceiver ON or OFF.
  - Push once to display the volume level setting screen. (p. 9)
  - Push twice to display the squelch level setting screen. (p. 9)
- 7 MENU KEY [MENU]**  
Push to display or close the Menu screen.
- 8 CHANNEL 16/CALL CHANNEL KEY [16/C]**
- Push to select Channel 16. (p. 7)
  - Hold down for 1 second to select the Call channel. (p. 7)
- 9 SOFTWARE KEYS (pp. 4 ~ 5)**  
Scroll the key functions pushing [◀] or [▶], then push either of the 4 software keys to select the function displayed at the bottom of the display.
- 10 MICROPHONE CONNECTOR**
- CAUTION:** Be sure that the microphone connector is tightened completely (rotate clockwise) to maintain the transceiver's waterproof protection.
- 11 PTT SWITCH [PTT] (p. 10)**  
Hold down to transmit, release to receive.



## ■ Function Display

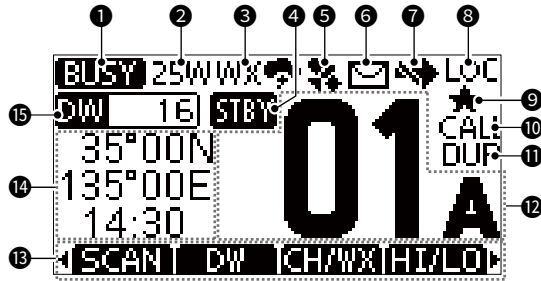

- 1 STATUS INDICATOR** (p. 10)
  - TX: Displayed while transmitting.
  - BUSY: Displayed while receiving, or the squelch is open.
- 2 POWER INDICATOR** (p. 5)
  - 25W: High power
  - 1W: Low power
- 3 CHANNEL GROUP INDICATOR** (pp. 7 ~ 8)
 

Displays the selected channel group, INT (International), USA, CAN (Canada), WX (Weather channel).

  - ① The selectable channels differ, depending on the version or presetting.
  - ① When the WX Alert is set to ON, "WX" is displayed. (For only the USA version)
- 4 STATUS INDICATOR**
  - STBY: Standby mode.
  - RT: Displayed while in the Radio Telephone (RT) mode.
  - ① Returns to the Standby mode if no operation occurs during the preset of time.
- 5 GPS ICON**
  - Displayed when valid GPS position data is received.
  - Blinks while no position data is received.
- 6 MAIL ICON** (p. 33)
  - Displayed when there is an unread DSC message.
  - Blinks until one of the called messages is read.
- 7 CHANNEL SWITCH ICON** (p. 36)
 

Displayed when the "CH Auto SW" is set to "Ignore after 10 sec." or "Manual."
- 8 LOCAL INDICATOR**

Displayed when the RF Attenuation is ON. (For only the USA version)
- 9 FAVORITE CHANNEL** (p. 13)
 

Displayed when a Favorite channel is selected.
- 10 CALL CHANNEL** (p. 10)
 

Displayed when a Call channel is selected.
- 11 DUPLEX CHANNEL**

Displayed when a Duplex channel is selected.
- 12 OPERATING CHANNEL NUMBER** (pp. 7, 11)
 

Displays the selected operating channel number.

  - ① "A" or "B" is displayed when a simplex channel is selected.
- 13 SOFTWARE KEYS FUNCTION DISPLAY** (p. 4 ~ 5)
 

The functions of each keys are displayed. See "Software keys" on the next page for details.

(☞ Continued on the next page)

## 2 PANEL DESCRIPTION

### ■ Function Display (Continued)

#### 14 POSITION/TIME READOUTS

Readouts the current position and time when valid GPS data is received, or when manually entered. (p. 16)

##### Received GPS data:

- “NO POS NO TIME” is displayed if no GPS data has been received, and then a warning message is displayed for 2 minutes after turning ON the transceiver.
- “??” blinks if no GPS data is received for 30 seconds after receiving valid GPS data, and then “??” and a warning message are displayed after 10 minutes.
- A warning message is displayed if no GPS data is received for 4 hours after receiving valid GPS data.

##### Manually entered GPS data:

- A manually entered GPS data is valid for 23.5 hours, and then a warning message is displayed.

#### 15 SCAN INDICATOR

- “SCAN” or “SCAN 16” is displayed while scanning. (p. 13)
- “DW” or “TW” and the watched channel number is displayed while using the Dualwatch or Tri-watch function. (p. 14)

### ■ Software Keys

Various often-used functions are assigned to the Software Keys for easy access. The functions’ icons are displayed above the Software Keys, as shown below.

#### ◇ Selecting a Software Key function

Push [◀] or [▶] to slide through the selectable functions that are assigned to the Software Keys.

Push the Software Key under the function’s icon to select the function.

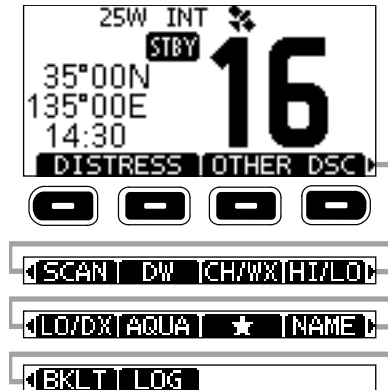

**NOTE:** The displayed icons or their order may differ, depending on the transceiver version or the presetting.

When the MMSI code is not set, the Software Keys for the DSC function are not displayed.

◇ Software key functions

Key	Function	Reference
<b>DISTRESS</b> Distress	<p>Push to display the “Distress” screen to select the nature of distress, then push the [DISTRESS] (red key) to make a call.</p> <p>① <b>DIRS</b> is displayed in the Multiple-task mode. (For only the USA version)</p> <p><i>NEVER MAKE A DISTRESS CALL IF YOUR SHIP OR A PERSON IS NOT IN AN EMERGENCY. A DISTRESS CALL SHOULD BE MADE ONLY WHEN IMMEDIATE HELP IS NEEDED.</i></p>	p. 18
<b>OTHER DSC</b> Other DSC	<p>Push to compose an Individual call, Group call, All Ships call or a Test call.</p> <p>① <b>OTH</b> is displayed in the Multiple-task mode. (For only the USA version)</p>	p. 20
<b>TASK</b> Task	<p>(For only the USA version)</p> <p>Displayed only in the Multiple-task mode.</p> <p>Push to display the task list.</p>	p. 34
<b>SCAN</b> Scan	<p>Push to start or stop a Normal or Priority scan.</p>	p. 13
<b>DW</b> / <b>TW</b> Dualwatch / Tri-watch	<p>Push to start or stop Dualwatch or Tri-watch.</p>	p. 14
<b>HI/LO</b> High/Low	<p>Push to set the output power to high or low.</p> <p>Some channels are set to only low power.</p>	p. 19
<b>CHWX</b> Channel/ Weather channel	<p>Push to select regular channels or Weather channels.</p> <p>① The Weather channel is for only the USA version.</p> <p><b>CHAN</b> is displayed for other versions.</p> <p>① While the Call channel or Channel 16 is displayed, push this key to return to the regular channel mode.</p>	p. 8
<b>LO/DX</b> Low/DX	<p>(For only the USA version)</p> <p>Push to turn the Attenuator ON or OFF.</p>	—
<b>AQUA</b> AquaQuake	<p>Hold down to turn ON the AquaQuake function to clear water from the speaker grill.</p>	p. 11
<b>★</b> Favorite channel	<p>Push to set or release the displayed channel as a Favorite channel.</p>	p. 13
<b>NAME</b> Channel Name	<p>Push to edit the name of the displayed channel.</p>	p. 11
<b>BKLT</b> Backlight	<p>Push to display the backlight brightness adjustment screen.</p> <p>① While in the adjustment mode, push [<b>▲</b>]/[<b>▼</b>]/[<b>◀</b>]/[<b>▶</b>] to adjust the brightness of the display and keys’ backlight to between 1 and 7, or OFF.</p>	p. 9
<b>LOG</b> LOG	<p>Push to display the received call log or distress message log.</p>	p. 33

# 3

## PREPARATION

### ■ Entering the MMSI code

The Maritime Mobile Service Identity (MMSI: DSC self ID) code consists of 9 digits. You can only enter the code when turning ON the transceiver for the first time.

**This initial code can be entered only once.**

After entering, it can be changed only by your dealer or distributor.

If your MMSI code has already been entered, doing the steps below is not necessary.

1. Hold down [PWR] to turn ON the transceiver.
  - Three short beeps sound, and “Push [ENT] to Register your MMSI” is displayed.
2. Push [ENT] to start entering the MMSI code.
  - The “MMSI Input” screen is displayed.
  - ① Push [CLR] twice to skip the entry.
    - If you skip the entry, you cannot make a DSC call. To enter the code after skipping, turn OFF the power, and then turn it ON again.
3. Enter the MMSI code.

**TIP:**

- Select a number using [◀] and [▶].
- Push [ENT] to enter the selected number.
- Select “←” or “→” on the screen to move the cursor.

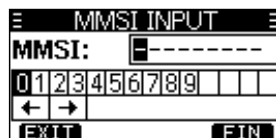

4. Repeat step 3 to enter all 9 digits.
  5. Push the software key below **FIN** to set the entered code.
    - The “Confirmation” screen is displayed.
  6. Enter your MMSI code again to confirm.
7. Push **FIN** to set the entered code.
    - When your MMSI code is successfully entered, “MMSI Successfully Registered” is briefly displayed, and then enters the operating screen.
- ① Your MMSI code is also displayed on the opening screen.

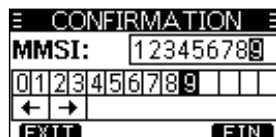

## ■ Selecting a channel

### ◇ Regular Channel

You can select a channel by pushing [▲] or [▼].

### ◇ Channel 16

Channel 16 is the distress and safety channel. It is used to establish the initial contact with a station, and for emergency communications. Channel 16 is monitored during both Dualwatch and Tri-watch. While in the standby mode, you must monitor Channel 16.

- Push [16/C] to select Channel 16.
  - ① To return to the previously selected channel, push [◀] or [▶] to display **CHAN** or **CHWX**, and then push the software key below **CHAN** or **CHWX**.

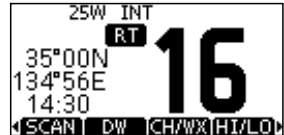

### ◇ Call channel

Each Channel Group has separate leisure-use Call channels. The Call channel is scanned during Tri-watch. The Call channels can be selected and used to store your most often used channels in each Channel Group, for quick recall. See page 10 for details on setting the Call channel.

- Hold down [16/C] for 1 second to select the Call channel.
  - The Call channel number and “CALL” are displayed.
  - ① To return to the previously selected channel, push [◀] or [▶] to display **CHAN** or **CHWX**, and then push the software key below **CHAN** or **CHWX**.

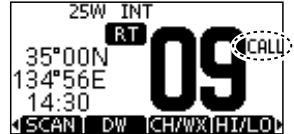

### ◇ Selecting a Channel Group

Channel Groups are preset into your transceiver. You can select a Channel Group for USA, International, and Canadian, depending on the transceiver version.

[MENU] > Radio Settings > **Channel Group**

1. Push [MENU].
  - The Menu screen is displayed.
2. Push [▲] or [▼] to select “Radio Settings,” and then push [ENT].
3. Push [▲] or [▼] to select “Channel Group,” and then push [ENT].
  - The “CHANNEL GROUP” screen is displayed.
4. Push [▲] or [▼] select a Channel Group, and then push [ENT].
5. Push **EXIT** to exit the Menu screen.
6. The selected Channel Group’s icon is displayed on the operating screen.

## 4 BASIC OPERATION

### ■ Weather channels and Weather Alert

The USA version transceiver has 10 preset Weather channels.

The transceivers are capable\* of monitoring broadcasts from the National Oceanographic and Atmospheric Administration (NOAA). The transceiver automatically detects a Weather alert tone on the selected weather channel, or while scanning.

\*When used within range of the broadcasts.

#### ◇ Selecting a Weather channel

1. Push **CH/WX**.
  - “WX” is displayed on the operating screen instead of the Channel Group.
2. Push [**▲**] or [**▼**] to select a Weather channel.

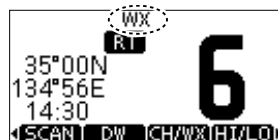

#### The Weather channel list

WX channel	Frequency (MHz)	WX channel	Frequency (MHz)
1	162.550	6	162.500
2	162.400	7	162.525
3	162.475	8	161.650
4	162.425	9	161.775
5	162.450	10	163.275

#### ◇ Setting the Weather Alert

To receive the weather alert, set the WX Alert to “On with Scan” or “On.”

[MENU] > Radio Settings > **WX Alert**

1. Push [MENU].
2. Push [**▲**] or [**▼**] to select “Radio Settings,” and then push [ENT].
3. Select “WX Alert,” and then push [ENT].
  - The “WX Alert” screen is displayed.
4. Select “On with Scan” or “On.”
  - “” is displayed next to the weather channel icon.



- ① “WX” blinks until you push a key after detecting an alert.



## ■ Adjusting the volume level

1. Push [VOL].
  - The volume adjustment screen is displayed.
2. Push [▲], [▼], [◀], or [▶] to adjust the audio volume level.
  - ① If no key is pushed for 5 seconds, the screen automatically closes.

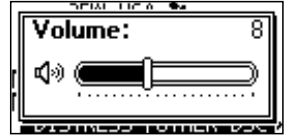

## ■ Adjusting the squelch level

Squelch enables the audio to be heard only while receiving a signal that is stronger than the set level. A higher level blocks weak signals, so that you can receive only stronger signals. A lower level enables you to hear weak signals.

1. Push [VOL] twice.
  - The squelch level adjustment screen is displayed.
2. Push [▲], [▼], [◀], or [▶] to adjust the squelch level.
  - ① If no key is pushed for 5 seconds, the screen automatically closes.

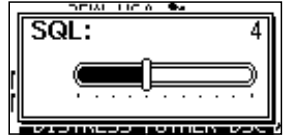

## ■ Adjusting the backlight or the display contrast

1. Open the "BACKLIGHT" or "CONTRAST" screen.
  - [MENU] > Configuration > **Backlight**
  - [MENU] > Configuration > **Display Contrast**
2. Push [▲], [▼], [◀], or [▶] to adjust, and then push [ENT] to set.
3. Push **EXIT** to exit the Menu screen.

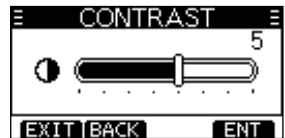
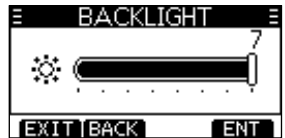

## 4 BASIC OPERATION

### ■ Setting the Call channel

By default, a Call channel is set in each Channel Group.  
You can set your most often-used channel as your Call channel in each Channel Group for quick recall.

1. Open the "CALL CHANNEL" screen.

[MENU] > Radio Settings > **Call Channel**

2. Push [▲] or [▼] to select the channel.
3. Push [ENT] to set the selected channel as the Call channel.
4. Push **EXIT** to exit the Menu screen.



### ■ Receiving and transmitting

**CAUTION: DO NOT** transmit without an antenna.

1. Push [▲] or [▼] to select the channel to call on.
  - The channel number and name are briefly displayed.
  - (Only when "CH Close-up" is ON.)
  - ① **BSY** is displayed while receiving a signal.
2. Hold down [PTT] and speak into the microphone at your normal voice level.
  - **TX** is displayed while transmitting.
3. Release [PTT] to receive.

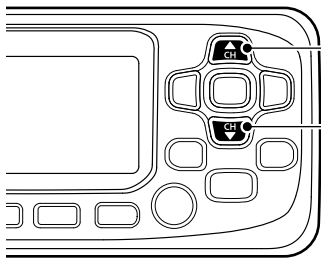

- ① Select a channel
- ② Hold down [PTT] and speak into the microphone
- ③ Release [PTT] to receive

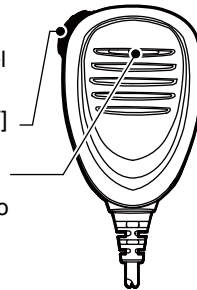

**TIP:** To maximize the readability of your transmitted signal, pause for a second after holding down [PTT] and hold the microphone 5 to 10 cm (2 to 4 inches) from your mouth, and then speak at your normal voice level.

**NOTE:** The Time-out Timer function cuts OFF transmission after 5 minutes of continuously transmitting, to prevent prolonged transmission.



## ■ AquaQuake Water Draining function

Water in the speaker grill may muffle the sound coming from the speaker. The AquaQuake Water Draining function removes water from the speaker grill by vibrating the speaker cone.

**CAUTION: DO NOT** use the AquaQuake Water Draining function when an external speaker is connected.

1. Push [◀] or [▶] to display **AQUA**.
2. Hold down **AQUA** to turn ON the function.
  - A low frequency vibration beep sounds to drain the water, regardless of the volume level setting.
  - ① This function is activated for a maximum of 10 seconds, even if you continue to hold down **AQUA**.
3. Release the key to turn OFF the function.



## ■ Editing a channel name

You can edit the name of each operating channel and weather channel, using numbers, uppercase letters, symbols, and a space. This enables easy recognition of the channels or stations. All VHF marine channels are set with default names.

① You can edit channel names only when the “CH Close-up” is set to ON.

[MENU] > Radio Settings > **CH Close-up**

1. Push [▲] or [▼] to select the channel to edit.
2. Push [◀] or [▶] to display **NAME**.
  - ① You cannot edit a channel name during Dualwatch, Tri-watch, or a scan.
3. Push **NAME**.
  - The “CHANNEL NAME” screen is displayed.
4. Edit the channel name.
5. Push **FIN** to save the edited name and return to the operating screen.



### TIP:

- Push **123** to display numbers, or **!\$?** to display characters.



- Select characters or space using [▲]/[▼]/[◀]/[▶].
- Select “◀” or “▶” on the screen to scroll.
- Push [ENT] to enter the selected character.
- Select “←” or “→” on the screen to move the cursor.

# 5 SCAN OPERATION

## ■ Scan types

You can find ongoing communication by scanning the Favorite channels.

### Before starting a scan :

- Set the channels that you want to scan as Favorite channels. (p. 13)
  - ① Only the Favorite channels are scanned.
- Set the scan type to "Priority Scan" or "Normal Scan" on the "Radio Settings" screen. (p. 41)

[MENU] > Radio Settings > **Scan Type**

### Normal Scan

Sequentially searches through all Favorite channels. Channel 16 is not scanned unless it is set as a Favorite channel.

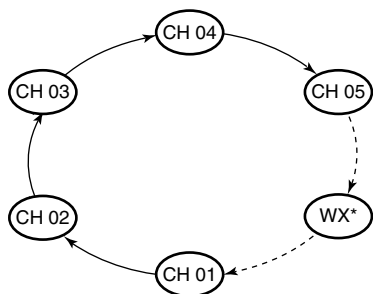

\*For the USA version. When the Weather Alert function is ON, the previously selected Weather channel is also scanned.

### Priority Scan

Sequentially searches through all Favorite channels, while also periodically checking Channel 16.

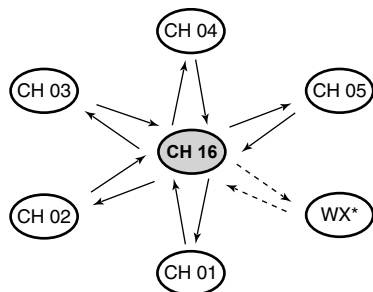

\*For the USA version. When the Weather Alert function is ON, the previously selected Weather channel is also scanned.

### When a signal is received:

**On Channel 16:**

The scan pauses until the signal disappears.

**On a channel other than Channel 16:**

The scan becomes Dualwatch until the signal disappears.

## ■ Setting Favorite channels

You can quickly recall often-used channels by setting them as Favorite channels. You can set Favorite channels in each Channel Group.

1. Select a Channel Group on the Menu screen. (p. 7)  
[MENU] > Radio Settings > Channel Group
2. Push [▲] or [▼] to select the channel.
3. Push [◀] or [▶] to display ★.
4. Push ★.
  - The selected channel is set as a Favorite channel, and “★” is displayed.
  - ① To cancel the setting, push ★ again.

**TIP:** You can set all channels as Favorite channels, clear all settings, or reset to the defaults. By default, some channels are preset as Favorite channels. The preset channels differ, depending on the transceiver version.

## ■ Starting a scan

**Example:** Starting a Normal Scan.

1. Select a Channel Group on the Menu screen. (p. 7)  
[MENU] > Radio Settings > Channel Group
2. Push [◀] or [▶] to display SCAN.
3. Push SCAN.
  - The scan starts.
  - SCAN is displayed during a Normal Scan, and SCAN 16 is displayed during a Priority Scan.
  - SCAN and BUSY are displayed when a signal is received.
  - ① When a signal is received, the scan pauses until it disappears, or resumes after 5 seconds, depending on the Scan Timer setting in “Radio Settings.”
  - ① A beep sounds and “16” blinks when a signal is received on Channel 16 during a Priority scan.
4. To stop the scan, push SCAN.

**TIP:** To properly receive signals, be sure to adjust the squelch to a suitable level.

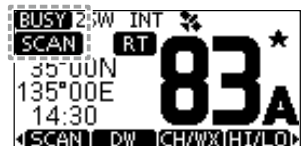

# 6

## DUALWATCH/TRI-WATCH

### ■ Description

Dualwatch and Tri-watch are convenient to periodically check Channel 16 while you are operating on another channel.

#### Dualwatch

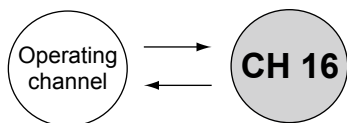

Periodically checks Channel 16 while operating on another channel.

#### Tri-watch

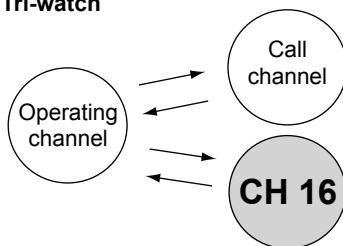

Periodically checks Channel 16 and the Call channel while operating on another channel.

#### When a signal is received:

**On Channel 16:** Dualwatch/Tri-watch pauses on Channel 16 until the signal disappears.

**On the Call channel:** Tri-watch switches to Dualwatch until the signal on the Call channel disappears.

### ■ Operation

1. Select Dualwatch or Tri-watch on the Menu screen.

[MENU] > Radio Settings > **Dual/Tri-Watch**

2. Push [▲] or [▼] to select a channel.
3. Push [◀] or [▶] to display **DW** (Dualwatch) or **TW** (Tri-watch).

4. Push **DW** or **TW**.

- Dualwatch or Tri-watch starts.
- "**DW 16**" is displayed for Dualwatch, or "**TW 16**" is displayed for Tri-watch.

① "**BUSY**" is displayed when a signal is received.

② A beep sounds and "**DW 16**" or "**TW 16**" blinks when a signal is received on Channel 16.

5. To cancel Dualwatch or Tri-watch, push **DW** or **TW** again.



## ■ DSC address ID

### ◇ Entering an Individual or Group ID

You can enter a total of 60 Individual IDs and 30 Group IDs, and assign names to them of up to 10 characters.

1. Open the "INDIVIDUAL ID" or "Group ID" screen.

[MENU] > DSC Settings > **Individual ID**

[MENU] > DSC Settings > **Group ID**

2. Push **ADD**.
  - "No ID" is displayed if no ID is entered.
3. Enter an Individual or Group ID.

#### TIP:

- Select a number using [◀]/[▶].
- Push [ENT] to set the selected number.
- Select "←" or "→" on the screen to move the cursor.

#### NOTE:

- For a Group ID, the first digit is fixed as "0."
- For any coast station ID, the first two digits are fixed as "0."

4. Push **FIN**.
  - The name entry screen is displayed.
5. Enter the ID's name.

#### TIP:

- Push **123** to use numbers, and push **!\$?** to use characters and letters.



- Select characters or space using [▲]/[▼]/[◀]/[▶].
- Select "◀" or "▶" on the screen to scroll.
- Push [ENT] to enter the selected character.
- Select "←" or "→" on the screen to move the cursor.

6. After entering, push **FIN** to save, and return to the previous screen.
  - The entered name is displayed.

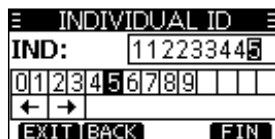

# 7 DIGITAL SELECTIVE CALLING (DSC)

## ◇ Deleting an entered ID

(Example: Deleting an Individual ID: STATION 2)

1. Open the "INDIVIDUAL ID" screen.  
[MENU] > DSC Settings > **Individual ID**
2. Select "STATION 2," and then push **DEL**.
  - "Are You Sure?" is displayed.
3. Push **OK** to delete.
  - ① Push **CANCEL** to cancel the deletion.
    - The selected ID is deleted, and then returns to the previous screen.



**TIP:** You can edit an ID and its name by pushing **EDIT** in step 2.

## ■ Entering the position and time

A Distress call should include the vessel's position, date, and time. If no GPS data is received, manually enter the position and Universal Time Coordinated (UTC) time.

**NOTE:**

- The manual entry is disabled while valid GPS data is received.
- The manually entered position and time is valid only for 23.5 hours, or until turning OFF the transceiver.

1. Open the "POSITION INPUT" screen.  
[MENU] > DSC Settings > **Position Input**

2. Enter the latitude.

**TIP:**

- Select a number or a compass direction using [**▲**]/[**▼**]/[**◀**]/[**▶**].
- Select "**←**" or "**→**" on the screen to move the cursor.
- Push [ENT] or **FIN** to save the selected number.

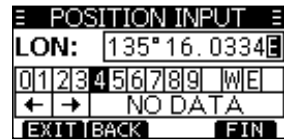
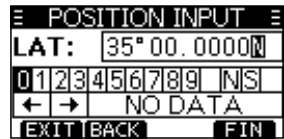

3. Enter the longitude and the UTC time.
  - ① See the TIP in step 2 to enter.
4. Push **FIN** to set the entered position and time.
5. Push **EXIT** to return to the standby screen.
  - The "DSC Settings" screen is displayed.



## ■ Sending DSC calls (Distress)

A Distress call should be sent if, in the opinion of the captain, the ship or a person is in distress and requires immediate assistance.

**NEVER MAKE A DISTRESS CALL IF YOUR SHIP OR A PERSON IS NOT IN AN EMERGENCY. A DISTRESS CALL SHOULD BE MADE ONLY WHEN IMMEDIATE HELP IS NEEDED.**

### ◇ Simple call

1. Confirm that no Distress call is being received.
2. While lifting up the key cover, hold down [DISTRESS] for 3 seconds until you hear 3 short countdown beeps and a long beep sound.
  - The backlight blinks.

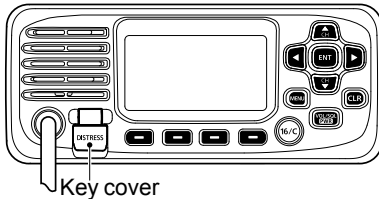

3. After sending, wait for an Acknowledgment call.
  - "Waiting for ACK" is displayed.
  - The Distress call is automatically sent every 3.5 to 4.5 minutes, until an Acknowledgement is received, or a Distress Cancel call is sent.
4. When you receive an Acknowledgment, an alarm sounds. Push **ALARM OFF** to turn OFF the alarm.
  - Channel 16 is automatically selected.
5. Hold down [PTT], and then explain your situation.
6. After you have finished your conversation, push **CANCEL** to return to the operating screen.

!! DISTRESS !!  
Hold Down  
for 3 sec.

!! DISTRESS !!  
Transmitting  
Distress Alert

!! DISTRESS !!  
Waiting for ACK  
Next TX after  
4 min. 6 sec.  
CANCEL RESEND

RCVD DTRS ACK  
FROM: 123456789  
CH 16  
ELAPSED: 00:00:03  
ALARM OFF

**TIP:** A default Distress alert contains:

- Nature of distress: Undesignated distress
- Position information: The latest GPS, or manually input position, that is held for 23.5 hours, or until you turn OFF the transceiver.

# 7 DIGITAL SELECTIVE CALLING (DSC)

## ◇ Regular call

Select the nature of the Distress call to include in the Regular Distress call.

1. Push **DISTRESS**.
  - The "DISTRESS" screen is displayed.
2. Push [ENT] to enter the Nature selection mode.
3. Select the nature of the Distress, and then push [ENT]. (Example: Flooding)
  - The setting is saved and returns to the previous screen.
  - ① If no valid GPS data is being received, select "Position," and then enter the latitude, longitude, and UTC.  
See "Entering the position and time" on page 16 for details.
4. While lifting up the key cover, hold down [DISTRESS] (the red button) for 3 seconds until you hear 3 short countdown beeps and a long beep sound.
  - The backlight blinks.
5. After sending, wait for an Acknowledgment.
  - "Waiting for ACK" is displayed.
  - ① The Distress call is automatically sent every 3.5 to 4.5 minutes, until an Acknowledgment is received, or a Distress Cancel call is sent. (p. 19)
6. When you receive an Acknowledgment, an alarm sounds. Push **ALARM OFF** to turn OFF the alarm.
  - Channel 16 is automatically selected.
7. Hold down [PTT] to communicate.

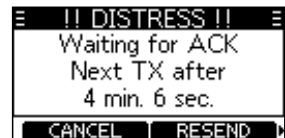
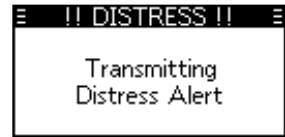
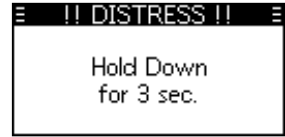

**TIP:** You can also send a Regular call by selecting the "Distress" item on the Menu screen.



## ◇ Distress Cancel call

If you have accidentally made a Distress call, or made an incorrect Distress call, send a Distress Cancel call to cancel the call as soon as possible while waiting for an Acknowledgement. Be sure to report the purpose of the cancellation.

1. While waiting for an Acknowledgement, push **CANCEL**.
  - The screen to the right is displayed.
2. Push **CONTINUE**.
  - The Distress Cancel call is sent.
  - Channel 16 is automatically selected.

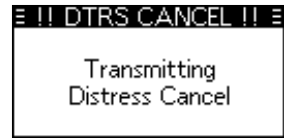
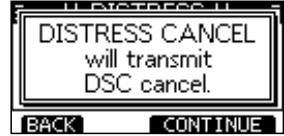

3. Hold down [PTT] to report the purpose of the cancellation.
  - ① You can display the wording of the cancellation by pushing [▼].



4. After communicating, push **FINISH**.
  - ① The screen to the right is displayed.



5. Push **STBY** to finish the Distress Cancel call.
  - Returns to the operating screen.

## ◇ Distress call Software Key description

### While waiting for an Acknowledgement:

- CANCEL**: Cancels the Distress call and enables you to send a Cancel call.
- RESEND**: Enables you to resend the Distress call by holding down [DISTRSS] again.
- PAUSE**: Pauses the countdown to resend the next Distress call.
- INFO**: Displays the information of the Distress call that you have sent.

### After receiving an Acknowledgement:

- STBY**: Closes the Distress operation, and returns to the operating screen.
- INFO**: Displays the information of the received Distress Acknowledgement.
- HIST**: Displays the "DISTRESS HISTORY."
- HI/LO**: Changes the output power.

# 7 DIGITAL SELECTIVE CALLING (DSC)

## ■ Sending DSC calls (other)

**NOTE:** To ensure proper DSC operation, be sure to correctly adjust the “CH 70 SQL Level” item on the Menu screen. (p. 37)

### ◇ Sending an Individual call

An Individual call enables you to send a DSC signal to only a specific station. You can communicate after receiving the Acknowledgement “Able to comply.”

1. Push **OTHER DSC**.
  - The “OTHER DSC” screen is displayed.
  - ① You can also display the “OTHER DSC” screen by selecting the “Other DSC” item on the Menu screen.
2. Select “Type,” and then push [ENT].
3. Select “Individual Call,” and then push [ENT].
  - Returns to the “OTHER DSC” screen.
4. Select “Address,” and then push [ENT].
5. Select the station to send an Individual call to, and then push [ENT].
  - Returns to the “OTHER DSC” screen.
  - ① You can also select “Manual Input” to manually enter the target station ID.
6. Select “Channel,” and then push [ENT].
7. Select a channel to assign, and then push [ENT].
  - ① The assigned channels are preset by default.
8. Push **CALL** to send the Individual call.
  - “Transmitting Individual Call” is displayed, and then “Waiting for ACK” is displayed.
  - ① If Channel 70 is busy, the transceiver stands by until the channel becomes clear.
9. When you receive an Acknowledgement “Able to comply”:
  - An alarm sounds.
  - The screen to the right is displayed.
10. Push **ALARM OFF** to turn OFF the alarm.
  - The channel assigned in step 7 is automatically selected.
  - ① If the called station cannot use the channel that you assigned, a different channel is selected by the other station.
11. Hold down [PTT] to communicate.

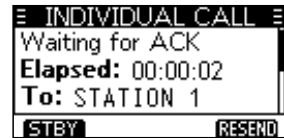
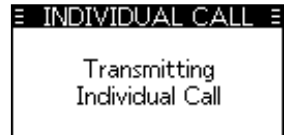
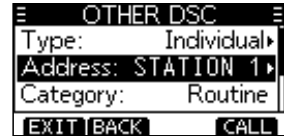

**TIP:** If you received an Acknowledgement “Unable to comply”:

1. Push **ALARM OFF** to turn OFF the alarm.
  - The Acknowledge information is displayed.
2. Push **STBY**, and then **OK** to return to the operating screen.

### ◇ Sending an Individual Acknowledgement

When you have received an Individual call (p. 29), send an Acknowledgement to the calling station. When the Auto Ack is set to "Manual," you can select an appropriate acknowledgement type.

1. While an Individual call is being received, push **ALARM OFF** to turn OFF the alarm.
  - The received call's information is displayed.
2. Push **ACPT**.
  - The Acknowledgement category screen is displayed.
  - ① If you want to send an Acknowledgement "Able to comply" right away, push **ABLE**.
  - ① If you cannot communicate, and want to return to the operating screen, push **IGN**.



3. Push **ABLE**, **UNABLE**, or **NEWCH** to select the Acknowledgement type.

**ABLE:** Sends an Acknowledgement without any changes.  
(Able to Comply)

**UNABLE:** Sends an Acknowledgement but cannot communicate.  
(Unable to Comply):

**NEWCH:** Able to communicate but proposes another channel. Specify the channel by pushing [**▲**] or [**▼**].  
(Example: Channel 69)



4. Push **CALL** to send the Acknowledgement.

## 7 DIGITAL SELECTIVE CALLING (DSC)

### ◇ Sending an All Ships call

All Ships that have DSC transceiver use Channel 70 as their listening channel. When you want to announce a message to these ships, if they are within range, use the All Ships Call.

1. Push **OTHER DSC**.
  - The “OTHER DSC” screen is displayed.
  - ① You can also display the “OTHER DSC” screen by selecting the “Other DSC” item on the Menu screen.
2. Select “Type,” and then push [ENT].
  - The “MESSAGE TYPE” screen is displayed.
3. Select “All Ships,” and then push [ENT].
  - The All Ships call is selected, and returns to the “OTHER DSC” screen.
4. Select “Category,” and then push [ENT].
  - The “CATEGORY” screen is displayed.
5. Select a category of the call, and the push [ENT].
  - The category is set, and returns to the “OTHER DSC” screen.
6. Select “Channel,” and then push [ENT].
7. Select the channel to assign, and then push [ENT].
  - ① The assigned channels are preset by default.
8. Push **CALL** to send the All Ships call.
  - “Transmitting All Ships Call” is displayed, and then the assigned channel is automatically selected.
  - ① If Channel 70 is busy, the transceiver stands by until the channel becomes clear.
9. Hold down [PTT] to communicate.

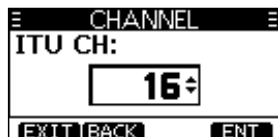
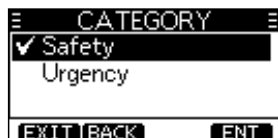

## ◇ Sending a Group call

A Group call enables you to send a DSC call to only a specific group.

① You can send a Group call to a pre-entered group address, or manually enter the address before sending. (p. 15)

1. Push **OTHER DSC**.
  - The “OTHER DSC” screen is displayed.
  - ① You can also display the “OTHER DSC” screen by selecting the “Other DSC” item on the Menu screen.
2. Select “Type,” and then push [ENT].
  - The “MESSAGE TYPE” screen is displayed.
3. Select “Group,” and then push [ENT].
  - The Group call is selected, and returns to the “OTHER DSC” screen.
4. Select “Address,” and then push [ENT].
  - The “ADDRESS” screen is displayed.
5. Select the group to send a Group call, and then push [ENT].
  - ① You can also select “Manual Input” to manually enter the target group.
6. Select “Channel,” and then push [ENT].
7. Select the channel to assign, and then push [ENT].
  - ① The assigned channels are preset by default.
8. Push **CALL** to send the Group call.
  - “Transmitting Group Call” is displayed, and then the assigned channel is automatically selected.
  - ① If Channel 70 is busy, the transceiver stands by until the channel becomes clear.
9. Hold down [PTT] to communicate.

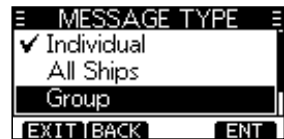

7



# 7 DIGITAL SELECTIVE CALLING (DSC)

## ◇ Sending a Test call

You should avoid testing calls on the exclusive DSC Distress channels and safety calling channels. When you cannot avoid testing on a Distress or safety channel, you should indicate that these are test calls.

Normally the Test call would require no further communications between the two stations involved.

1. Push **OTHER DSC**.
  - The "Other DSC" screen is displayed.
  - ① You can also display the "Other DSC" screen by selecting the "Other DSC" item on the Menu screen.
2. Select "Test," and then push [ENT].
  - The Test call is selected, and returns to the "OTHER DSC" screen.
3. Select "Address," and then push [ENT].
  - The "ADDRESS" screen is displayed.
4. Select a station to send the Test call to.
  - ① You can also select "Manual Input" to manually enter the calling station.
5. Push **CALL** to send the Test call.
  - ① If Channel 70 is busy, the transceiver stands by until the channel becomes clear.
6. When you receive an Acknowledgement:
  - An alarm sounds.
  - The screen to the right is displayed.
7. Push **ALARM OFF** to turn OFF the alarm.
  - The Acknowledgement information is displayed.
8. Push **CLOSE**.
  - The received call's information is displayed.
  - The call is saved in the DSC Log.
9. Push **STBY** to return to the operating screen.

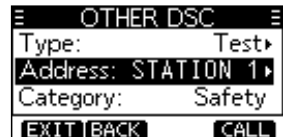
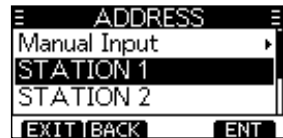

## ◇ Sending a Test Acknowledgement

By default, when you receive a Test call, the Auto ACK function automatically sends an Acknowledgement to the calling station (p. 36). If the function is set to “Manual,” do the following steps to send an Acknowledgement.

1. After a Test call is being received, push **ALARM OFF** to turn OFF the alarm.
2. Push **ACPT**.
  - The received call's information is displayed.
3. Push **ACK**.
  - The “Test ACK” confirmation screen is displayed.
4. Push **CALL** to send the Acknowledgement.
  - “Transmitting Test ACK” is displayed.
5. Push **STBY**, and then push **OK** to return to the operating screen.

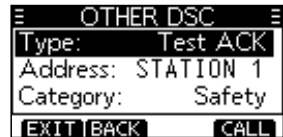

# 7 DIGITAL SELECTIVE CALLING (DSC)

## ◇ Sending a Position Request call/Polling Request call

(For only the USA version)

You can send a Position Request call or Polling request call to a station, depending on the presetting.

Send a Position Request call when you want to know a specific ship's current position.

### Example: Sending a Position Request call

1. Push **OTHER DSC**.
  - The "OTHER DSC" screen is displayed.
  - ① You can also display the "OTHER DSC" screen by selecting the "Other DSC" item on the Menu screen.
2. Select "Type," and then push [ENT].
3. Select "Position," and then push [ENT].
  - ① When you send a Polling Request call, select "Polling."
  - The message type is selected, and returns to the "OTHER DSC" screen.
4. Select "Address," and then push [ENT].
5. Select a target to send a Position Request call to, and then push [ENT].
  - ① You can also select "Manual Input" to manually enter the target ID.
6. Push **CALL** to send the Position Request call.
  - Position Request call is sent, and then "Waiting for ACK" is displayed.
  - ① If Channel 70 is busy, the transceiver stands by until the channel becomes clear.
7. When you receive a Position Reply:
  - An alarm sounds.
  - The screen to the right is displayed.
8. Push **ALARM OFF** to turn OFF the alarm.
9. Push **CLOSE**.
  - The received information is displayed.
10. Push [▲] or [▼] to scroll the screen, and then check the target's position.
11. Push **STBY**, and then **OK** to return to the operating screen.

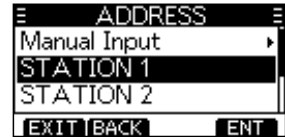



◇ Sending a Position Reply call

Send a Position Reply call when a Position Request call is received.

If the Auto ACK function is set to “Auto,” the Acknowledgement is automatically sent to the calling station. (p. 36)

1. While a Position Request call is being received, push **ALARM OFF** to turn OFF the alarm.
2. Push **ACPT**.
  - The received call's information is displayed.



3. Push **ABLE** to send an “Able to Comply” Acknowledgement, or push **UNABLE** to send an “Unable to Comply” Acknowledgement.
  - ① If no valid GPS position is received, you can manually enter the position and time in “Position” item on this screen. See “Entering the position and time” on page 16 for details.
4. Push **CALL** to send the Position Reply call.
5. Push **STBY**, and then **OK** to return to the operating screen.

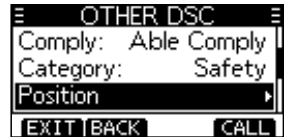

# 7 DIGITAL SELECTIVE CALLING (DSC)

## ■ Receiving DSC calls (Distress)

The transceiver receives Distress calls, Distress Acknowledgements, and Distress Cancel calls.

When you receive a call, an emergency alarm sounds.

**NOTE:** The screens that are displayed when a Distress call or an Acknowledgement is received slightly differ from one another. The following steps are described using an example of receiving a Distress call.

### When a Distress call is received:

- The emergency alarm sounds until you turn it OFF.
- "RCVD DISTRESS" is displayed.

1. Push **ALARM OFF** to turn OFF the alarm.



2. Push the Software Key below the intended operation.

**IGN:** Returns to the operating screen.  
(Ignore) The call is saved in the DSC Log.  
"✉" blinks continuously until you display the call message.



**PAUSE:** **PAUSE** is not displayed if the "CH Auto SW" item is set to "Manual." (p. 36)  
(Pause) Pauses the countdown until the assigned channel is automatically selected.  
Select **RESUME** to resume the countdown.  
The call is saved in the DSC Log.

**ACPT:** Accepts the call.  
(Accept) Channel 16 is automatically selected.  
Monitor Channel 16 as a coast station may require assistance.  
After Channel 16 is selected, select your next operation by pushing the Software Key below the following options.

**STBY:** Returns to the operating screen.

**INFO:** Displays the information of the received Distress call.

**HIST:** Displays the "DISTRESS HISTORY" screen.



## ■ Receiving DSC calls (other)

The transceiver receives the following types of DSC calls.

- Individual call (p. 29)
- Individual Acknowledgement (p. 21)
- Group call (p. 30)
- All Ships call (p. 30)
- Position Request call (p. 31)
- Test call (p. 32)
- Test Acknowledgement (p. 24)

① The receivable call types may differ, depending on the transceiver version or presetting.

By default, the Auto ACK function automatically sends an Acknowledgement to the calling station. ([MENU] > DSC Settings > **Auto ACK** (p. 36))

If Auto ACK is set to "Manual," you can manually send an Acknowledgement for each call as described in this section.

### ◇ Receiving an Individual call

**When an Individual call is received:**

- An alarm sounds.
- "RCVD INDIVIDUAL" is displayed.

1. Push **ALARM OFF** to turn OFF the alarm.



2. Push the Software Key below the next operation.

**IGN:** Ignores the call and returns to the operating screen. (Ignore)

- The call is saved in the DSC Log.
- "☐" blinks continuously until you display the call message.

**ABLE:** Sends an Individual Acknowledgement right away. (Able to comply)

- Automatically switches to the assigned channel.
- After sending, push **RESEND** to resend.
- The call is saved in the DSC Log.

**ACPT:** Accepts the call. (Accept)

- The call is saved in the DSC Log.
- The received call's information is displayed.
- Push the Software Key to select the Acknowledgement option.

**ABLE:** Sends an Acknowledgement without any changes. (Able to Comply)

**UNABLE:** Sends an Acknowledgement but cannot communicate. (Unable to Comply)

**NEW CH:** Able to communicate but proposes another channel. (Propose New CH) Specify the channel by pushing [▲] or [▼].



# 7 DIGITAL SELECTIVE CALLING (DSC)

## ◇ Receiving a Group call or All Ships call

### When a Group call is received:

- An alarm sounds.
- “RCVD GROUP CALL” is displayed.

(Example: when a Group call is received)



### When an All Ships call is received:

- An alarm sounds.
- “RCVD ALL SHIPS” is displayed.

1. Push **ALARM OFF** to turn OFF the alarm.
  - The channel that is assigned by the caller is automatically selected after 10 seconds by default.
2. Push the Software Key below your next operation.

**IGN**: Ignores the call and returns to the operating screen. (Ignore)

- The call is saved in the DSC Log.
- blinks continuously until you display the call message.



**PAUSE**: Pauses the countdown until the assigned channel is automatically selected. (Pause)

- Select **RESUME** to resume the countdown.
- The call is saved in the DSC Log.
- ① **PAUSE** is not displayed if the “CH Auto SW” item is set to “Manual.” (p. 36)

**ACPT**: Accepts the call.

- The assigned channel is selected.
- The call is saved in the DSC Log.

**STBY**: Closes the call, and then returns to the operating screen.

**INFO**: The received call's information is displayed.



## ◇ Receiving a Position Request call

(May not be used, depending on the presetting)

**NOTE:** Even if the Auto ACK function is set to “Manual,” after receiving a Distress Acknowledgement, or while in the Distress Cancel call procedure, the Position Reply is automatically sent to the calling station.

### When a Position Request call is received:

- An alarm sounds.
- “RCVD POS Request” is displayed.

1. Push **ALARM OFF** to turn OFF the alarm.
2. Push the Software Key below the intended operation.

**IGN:** Ignores the call and returns to the operating screen.  
(Ignore)

- The call is saved in the DSC Log.
- “” blinks continuously until you display the call message.

**ABLE:** Sends Acknowledgement “Able to comply” right away.  
(Able to comply)

**UNABLE:** Sends an Acknowledgement “Unable to Comply.”  
(Unable to Comply)

- The call is saved in the DSC Log.
- Displays the Acknowledgement information, and then returns to the operating screen by pushing **EXIT**.

**ACPT:** Accepts the call.  
(Accept)

- Displays the received call’s information.
- The call is saved in the DSC Log.

Push **ABLE** or **UNABLE**, then push **CALL** to send the Position Reply call. (p. 27)

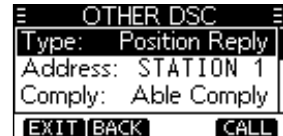

## 7 DIGITAL SELECTIVE CALLING (DSC)

### ◇ Receiving a Test call

#### When a Test call is received:

- An alarm sounds.
- "RCVD TEST CALL" is displayed.

1. Push **ALARM OFF** to turn OFF the alarm.



2. Push the Software Key below your next operation.

**IGN**: Ignores the call and returns to the operating screen (Ignore)

- The call is saved in the DSC Log.
- "☐" blinks continuously until you display the call message.

**ABLE**: Sends a Test Acknowledgement "Able to Comply." (Able to comply)

- The call is saved in the DSC Log.

**ACPT**: Accepts the call.

- Displays the received call's information.
- The call is saved in the DSC Log.
- The received call's information is displayed.

Push **ACK**, and then push **CALL** to send a Test Acknowledgement. (p. 25)

Push **RESEND** to resend.

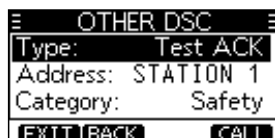
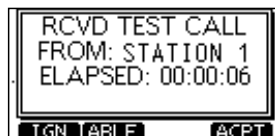

## ■ DSC Log

### ◇ Received DSC Log

The transceiver saves up to 30 received Distress call messages and 50 received “Others” call messages in your DSC Log.

On the operating screen,  is displayed when there is an unread call message. The icon blinks when there is a new received call message.

1. Open the “DSC Log” screen.

[MENU] > **DSC Log**

2. Select “Received Call Log,” and then push [ENT].
  - The “RCVD CALL LOG” screen is displayed.
3. Select “Distress” or “Others,” and then push [ENT].
  - ① “Distress” displays the received Distress call log, and “Others” displays the received DSC call log.

**TIP:** You can also display the “Received” screen by pushing **LOG** on the operating screen.

4. Select a log, and then push [ENT] to display the detailed information.

**EXIT:** Returns to the operating screen.

**BACK:** Returns to the previous screen.

**DEL:** Deletes the selected call log.

**MMSI:** Saves the MMSI as an Individual ID.

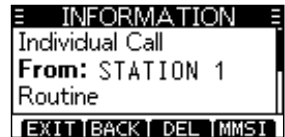

### ◇ Transmitted DSC Log

The transceiver saves up to 30 DSC transmitted calls in your DSC Log.

1. Open the “DSC Log” screen.

[MENU] > **DSC Log**

2. Select “Transmitted Call Log,” and then push [ENT].
  - The “TX CALL LOG” screen is displayed.
3. Select a log, and then push [ENT] to display the detailed information.

**EXIT:** Returns to the operating screen.

**BACK:** Returns to the previous screen.

**DEL:** Deletes the selected call log.

**MMSI:** Saves the MMSI as an Individual ID or a Group ID.

## 7 DIGITAL SELECTIVE CALLING (DSC)

### ■ Multiple-task mode

(For only the USA version, depending on the presetting.)

If the Multiple-task function is enabled, the transceiver can hold up to 7 tasks. You can handle more than 2 DSC tasks simultaneously by switching between the tasks.

To use the Multiple-task mode, select "Multiple" in the "Procedure" on the Menu screen. (p.37)

[MENU] > DSC Settings > **Procedure**

When the Multiple-task mode is activated, **TASK** is displayed on the operating screen.

**NOTE:** The Task mode has a Time-out Timer (TOT) function. After a certain period of time has passed without any operation on a task, the transceiver automatically exits the Task mode and returns to the operating screen.

When a Time-out Timer activates, an alarm sounds and a count down message is displayed for 10 seconds.

### ◇ Holding a DSC task

In the Multiple-task mode, you can hold or activate the DSC task as follows.

#### Example: When a Group call is received:

1. Push **ALARM OFF** to turn OFF the alarm.
  - The received call's information is displayed.
2. Push **HOLD**.
  - The received Group call task is held into the task list and returns to the operating screen.



### ◇ Activating the held DSC task

1. Push **TASK** to display the task list.
  - The task list is displayed.
2. Select the task that you want to activate.
3. Push **ACTIVE** to activate the task.
  - The activated task information is displayed.
4. Push [PTT] to communicate.
5. After finishing the communication, push **DEL** to delete the task.





## ◇ Task list

When one or more tasks are held, you can display the task list screen by pushing **TASK**. The number of tasks is displayed at the top of the screen.

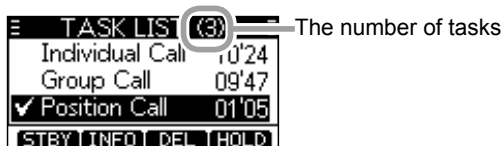

On the "TASK LIST" screen, the following Software Keys are displayed.

- STBY**: Holds the task and returns to the operating screen.
- INFO**: Displays the task information.
- DEL**: Finishes the selected task.
- HOLD**: Holds the selected task.
- ACTIVE**: Activates the selected task.

---

# 7 DIGITAL SELECTIVE CALLING (DSC)

## ■ DSC Settings

On the “DSC Settings” screen, you can make settings of the DSC call related items.

[MENU] > **DSC Settings**

---

### Position Input

See “Entering the position and time” on page 16 for details.

---

### Individual ID

See “Entering an Individual ID” on page 15 for details.

---

### Group ID

See “Entering a Group ID” on page 15 for details.

---

### Auto ACK

The Auto ACK function automatically sends an Acknowledgement when an appropriate Request is received.

- **Individual ACK**

Auto (Able): Automatically sends “Able to comply.”

Auto (Unable): Automatically sends “Unable to comply.”

Manual: Manually sends an Acknowledgement.

- **Position ACK**

Auto (Able): Automatically sends “Able to comply.”

Manual: Manually sends an Acknowledgement.

- **Polling ACK**

Auto: Automatically sends an Acknowledgement.

Manual: Manually sends an Acknowledgement.

- **Test ACK**

Auto: Automatically sends an Acknowledgement.

Manual: Manually sends an Acknowledgement.

---

### CH Auto SW

Select whether or not to automatically switch to channel 16 or the specified channel, or ignore the call.

Accept: After receiving a DSC call, the transceiver remains on the operating channel for 10 seconds. After that, the transceiver automatically switches to the channel that is specified on the DSC call.

Ignore: After receiving a DSC call, if you do not push the Software Key below [ACPT] in 10 seconds, the transceiver ignores the call, and then remains on the current operating channel.

Manual: After receiving a DSC call, you can select whether or not to accept the received DSC call.

**NOTE:** In the Multiple-task mode, “Accept” is renamed to “Accept after 10 sec.” and “Ignore” is renamed to “Hold after 10 sec.”

---

### Data Output

When receiving a DSC call from the station that is selected in this setting, the transceiver outputs the DSC data to the NMEA output port.

① You can send Distress calls despite of this setting.

All Stations: From any station.

Stations List: From the stations that are entered Individual ID or Group ID on the Menu screen.

OFF: Does not output any DSC data from the NMEA 0183 Output port.

### Alarm Status

Sets the alarm ON or OFF when receiving each type of DSC call.

- **Safety**
- **Routine**
- **Warning**

Sets the alarm for when:

- No MMSI code is entered.
- The position data has not been received for 2 minutes after turning ON the transceiver.
- The received position data has not been updated for 10 minutes.
- The received position data has not been updated for 4 hours.
- The manually entered position data has not been updated for 23.5 hours.

- **Self-Terminate**

An alarm sounds when duplicate Distress calls are received.

- **Discrete**

An alarm sounds when a lower priority call is received while receiving a high priority call.

### CH 70 SQL Level

Sets the Squelch level for Channel 70 to 1 ~ 10 or Open.

### Self-Test

The Self-Test sends DSC signals to the receiving AF circuit to compare the sending and receiving signals at the AF level.

Push [ENT] to start the Self-Test.

- ① When the sending and receiving DSC signals match, "OK" is displayed.

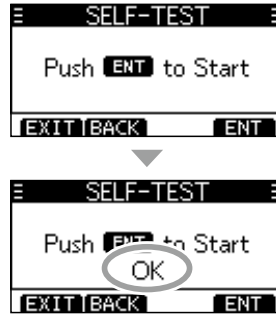

### Procedure

(For only the USA version)

You can select the type of task for the transceiver, depending on the presetting.

Single: Handles only 1 task at the same time.

Multiple: Handles up to 7 tasks at the same time.

## ■ Using the Menu screen

The Menu screen is used to set items, select options, and so on for the transceiver's functions.

### ◇ Menu screen operation

**Example:** Setting the key beep to "Off."

1. Push [MENU].
  - The Menu screen is displayed.
2. Push [▲] or [▼] to select "Configuration," and then push [ENT].
  - The "CONFIGURATION" screen is displayed.
  - ① Holding down [▲] or [▼] sequentially scrolls up or down through the Menu screen.
3. Push [▲] or [▼] to select "Key Beep," and then push [ENT].
  - The "KEY BEEP" screen is displayed.
4. Push [▲] or [▼] to select "Off," and then push [ENT].
  - "Off" is set and the transceiver returns to the previous screen.

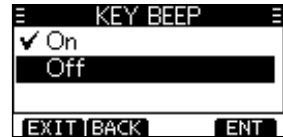
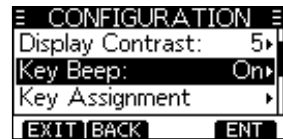

#### TIP:

- To exit the Menu screen, push **EXIT** or [MENU].
- To return to the previous screen, push **BACK** or [CLR].

◇ **Menu screen items**

The Menu screen contains the following items.

See the referred pages for each items.

The displayed menu items may differ, depending on the transceiver version or presetting.

Menu	Item	Reference
Distress	Nature	p. 17
	Position	p. 16
Other DSC	Type	p. 20
	Address	p. 20
	Category	p. 20
	Mode	p. 20
	Channel	p. 20
GPS	—	p. 40
Configuration	Backlight	p. 9
	Display Contrast	p. 9
	Key Beep	p. 40
	Key Assignment	p. 40
	UTC Offset	p. 40
	Inactivity Timer	p. 40
	GPS	p. 40
DSC Log	Received Call log	p. 33
	Transmitted Call Log	p. 33
Radio Settings	Scan Type	p. 41
	Scan Timer	p. 41
	Dual/Tri-watch	p. 41
	Channel Group	p. 41
	Call Channel	p. 41
	WX Alert	p. 41
	FAV Settings	p. 41
	CH Display	p. 41
	CH Close-up	p. 42
DSC Settings	Position Input	p. 36
	Individual ID	p. 36
	Group ID	p. 36
	Auto ACK	p. 36
	CH Auto SW	p. 36
	Data Output	p. 36
	Alarm Status	p. 37
	CH 70 SQL Level	p. 37
	Self-Test	p. 37
Procedure	p. 37	
Radio Info	—	p. 42

### ■ Menu items description

#### ◇ GPS

Displays the position information.

#### ◇ Configuration

##### **Backlight**

---

You can adjust the backlight brightness between 1 and 7, or OFF.

##### **Display Contrast**

---

You can adjust the display contrast level between 1 (lowest) and 8 (highest).

##### **Key Beep**

---

You can select whether or not to sound a beep when a key is pushed.

On: Sounds a beep when a key is pushed.

Off: No beep sounds, for silent operation.

##### **Key Assignment**

---

###### ● **Softkey 1~16**

You can change which Software Key functions to display, and their order. You can assign up to 16 Software Keys at a time.

- ① The usable Software Key functions and their order may differ, depending on the transceiver version or presetting.
- ① Some software keys may not be usable, depending on other item settings. ("X" is displayed at the right of the unusable key name.)

###### ● **Set Default**

Sets the Software Key function order as default.

- ① The default setting may differ, depending on the transceiver version or presetting.

##### **UTC Offset**

---

Set the offset time between Universal Time Coordinated (UTC) and your local time to between -14:00 and +14:00 (in 1 minute steps).

##### **Inactivity Timer**

---

The transceiver automatically returns to the operation screen if you push no key for the set period of time for each mode.

###### ● **Not DSC**

Setting for when a screen that is not related to DSC is displayed.

###### ● **DSC**

Setting for when a screen that is related to DSC is displayed.

###### ● **Distress**

Setting for when a screen that is related to a Distress call is displayed.

###### ● **RT**

Setting for when the transceiver is in the Radio Telephone mode.

##### **GPS**

---

Selects a satellite to be used for GPS (Global Positioning System) to pinpoint the geographic location of your transceiver anywhere in the world.

This setting may not be usable, depending on the transceiver version or presetting.

###### ● **GPS**

The GPS (Global Positioning System) is permanently set to ON.

###### ● **GLONASS**

Selects whether or not to use the data from the GLONASS (GLObal'naya NAVigatsionnaya Sputnikovaya Sistema) satellites.

###### ● **SBAS**

Turns the SBAS (Satellite Based Augmentation System) function ON or OFF.

When turning ON this function, the GPS position accuracy can be improved.

## ◇ Radio Settings

### Scan Type

Selects the scan type. The default setting differs, depending on the transceiver version.

① See page 12 for details.

**Normal Scan:** Scans all Favorite channels in the selected channel group.

**Priority Scan:** Sequentially scans all Favorite channels, while periodically checking Channel 16.

### Scan Timer

You can use the Scan Timer to pause, or to resume after 5 seconds, when a signal is detected.

**On:** When a signal is detected on a channel, the scan pauses for 5 seconds, and then resumes. If the signal disappears in less than 5 seconds, the scan immediately resumes.

**Off:** When a signal is detected on a channel, the scan pauses until the signal disappears, and then resumes.

### Dual/Tri-watch

Select Dualwatch or Tri-watch.

① See page 14 for details.

**Dualwatch:** Periodically checks Channel 16 while operating on another channel.

**Tri-watch:** Periodically checks Channel 16 and the Call channel while operating on another channel.

### Channel Group

Select the suitable channel group for your operating area. Select USA, INT, CAN, or DSC, depending on the transceiver version.

① See page 7 for details.

### Call Channel

You can change your Call channel. The default setting differs, depending on the transceiver version.

① See page 10 for details.

### WX Alert

For the USA version, an NOAA broadcast station transmits a Weather Alert tone before any important weather information.

① See page 8 for details.

**On with Scan:** The preset Weather channels are sequentially checked while scanning.

**On:** The previously selected (last used) Weather channel is checked while scanning.

**Off:** The Weather Alert tone is not detected.

### FAV Settings

You can set all channels as Favorite channels, clear all settings, or reset to default. By default, some channels are preset. The Favorite channels differ, depending on the transceiver version.

① See page 13 for details.

**Set All Channels:** Sets all channels as Favorite channels.

**Clear All Channels:** Clears all Favorite channels.

**Set Default:** Resets Favorite channels to the default.

### CH Display

You can select the number of digits to display the channel number.

① This setting may not be usable, depending on the transceiver version or presetting.

**3 Digits:** The channel number is displayed in 3 digits, such as "01A."

**4 Digits:** The channel number is displayed in 4 digits, such as "1001."

---

## 8 MENU SCREEN

### ◇ Radio Settings (Continued)

#### **CH Close-up**

---

You can select whether or not to display the channel name when changing the operating channel.

On: The channel number and the channel name are briefly displayed when changing the channel.

Off: The channel name is not displayed on the screen.

### ◇ **Radio Info**

Displays your transceiver's MMSI code, Software version, and GPS version, if built-in.





## ■ Supplied accessories

Mounting bracket

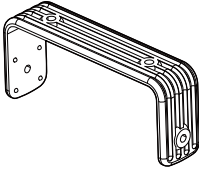

For mounting bracket

Knob bolts



Flat washers (M5)



Screws  
(5 × 20 mm)



Spring washers (M5)



Microphone

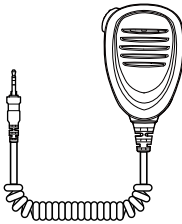

Microphone hanger  
and screws  
(3 × 16 mm)



DC power cable

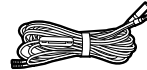

## ■ Connecting the microphone

1. Insert the microphone's screw connector to the microphone jack on the front panel.
2. Rotate the screw connector clockwise until it is completely tightened.

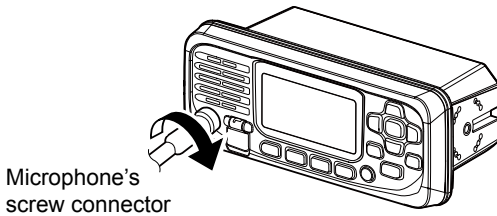

**CAUTION:** Be sure that the microphone connector is screwed completely, otherwise the transceiver may lose its waterproof protection.

# 9 CONNECTIONS AND MAINTENANCE

## ■ Connections

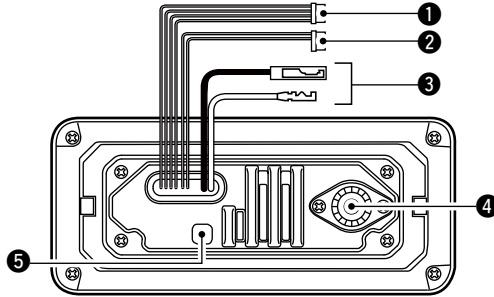

### 1 NMEA IN/OUT LEADS

Yellow: Listener A (Data-H), GPS In (+)

Green: Listener B (Data-L), GPS In (-)

Connect to the NMEA output lines of a GPS receiver for position data.

- NMEA 0183 (ver. 2.0 or later) sentence format RMC, GGA, GNS, or GLL and VTG compatible GPS receiver is required. Ask your dealer about suitable GPS receivers.
- The GPS sentences input from this connector are given priority to over the sentences input from the built-in GPS receiver.

White: Talker A (Data-H), Data Out (+)

Brown: Talker B (Data-L), Data Out (-)

Connect to NMEA 0183 input lines of navigation equipment, to receive position data from other ships.

- An NMEA 0183 (ver. 2.0 or later) sentence format DSC or DSE compatible navigation equipment is required.
- The built-in GPS outputs RMC, GSA, and GSV format sentences.

### 2 AF OUT LEADS

Connects to an external speaker.

Blue: External Speaker (+)

Black: External Speaker (-)

**NOTE for NMEA In/Out and AF Out leads:** The connectors are attached to keep the leads together. Before connecting to a piece of equipment, cut the leads to remove the connector.

### 3 DC POWER CONNECTOR

Connects to a 13.8 V DC power source.

(+: Red, -: Black)

**CAUTION:** After connecting the DC power cable, NMEA leads or external speaker leads, cover the connector and leads with a vulcanizing tape, as shown below, to prevent water seeping into the connection.

Rubber vulcanizing tape

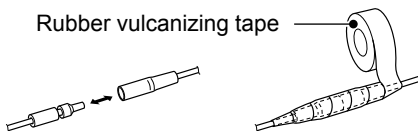

**4 ANTENNA CONNECTOR**

Connects to a marine VHF antenna with a PL-259 connector.  
A key element in the performance of any communication system is the antenna. Ask your dealer about antennas and the best place to mount them.

**CAUTION: DO NOT** transmit without an antenna.

**5 GROUND TERMINAL**

Connects to a vessel ground to prevent electrical shocks and interference from other equipment occurring.  
Use a PH M3 × 6 screw (user supplied).

**■ Connecting to the MA-510TR**

Connect the transceiver to the MA-510TR using the accessory cable. After connecting, an Individual DSC call can be made to the AIS target using the transponder without entering the target's MMSI code.

① See the MA-510TR instruction manual for connecting instruction.

- Connect each lead to the appropriate lead as follows.
  - Listener A (Data-H) (Yellow): NMEA IN (+)
  - Listener B (Data-L) (Green): NMEA IN (-)
  - Talker A (Data-H) (White): NMEA OUT (+)
  - Talker B (Data-L) (Brown): NMEA OUT (-)

9

**■ Fuse replacement**

One fuse is installed in the supplied DC power cable. If the fuse blows or the transceiver stops functioning, track down the source of the problem, repair it, and replace the damaged fuse with a new one of the proper rating.  
Fuse rating: 10 A

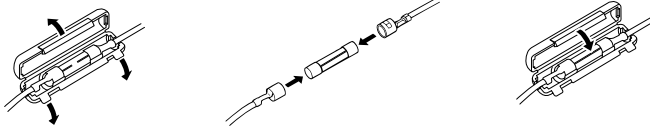

**■ Cleaning**

If the transceiver becomes dusty or dirty, wipe it clean with a soft, dry cloth.



**DO NOT** use harsh solvents such as Benzine or alcohol, as they will damage the transceiver's surfaces.

## ■ Mounting the transceiver

### ◇ Using the supplied mounting bracket

You can mount the transceiver on a dashboard using the universal mounting bracket supplied with your transceiver.

**CAUTION: KEEP** the transceiver and microphone at least 1 meter (3.3 ft) away from the vessel's magnetic navigation compass.

**NOTE for the IC-M220G:** The built-in GPS receiver is located, as shown to the right.

Be sure that the transceiver is positioned where the GPS receiver has a clear view to receive signal from satellites.

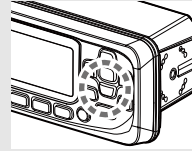

1. Mount the bracket securely to a surface which is more than 10 mm thick and can support more than 5 kg using the 2 supplied screws (5 × 20 mm).

**NOTE:** When mounting the transceiver on a board, fix the bracket to the board using the user supplied bolts and nuts, as shown below.

2. Attach the transceiver to the bracket so that the face of the transceiver is at 90° to your line of sight when operating it.  
① Adjust the function display angle to be easy-to-read.

### Mounting Example

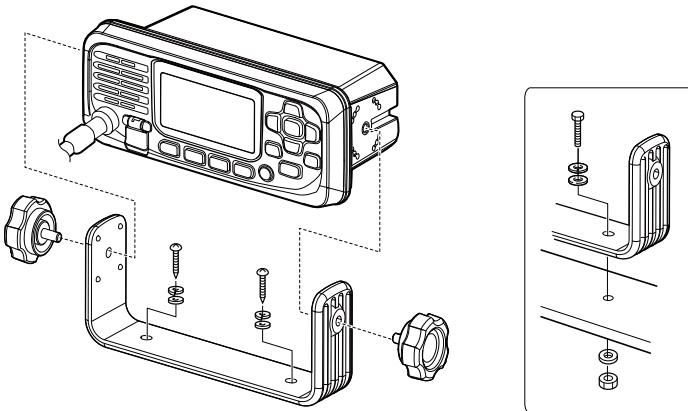

## ■ MBF-5 installation

The optional MBF-5 flush mount kit is for mounting the transceiver to a flat surface (less than 20 mm thick), such as an instrument panel.

**NOTE:** Install the transceiver and/or microphone more than 1 meter from the vessel's magnetic navigation compass.

1. Using the template on page 51, carefully cut a hole in the instrument panel, or wherever you plan to mount the transceiver.
2. Slide the transceiver through the hole, as shown to the right.

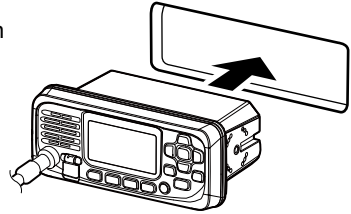

3. Attach the 2 bolts (5 × 8 mm) and spacer supplied with the MBF-5 to both sides of the transceiver. (Torque: 2 N•m)

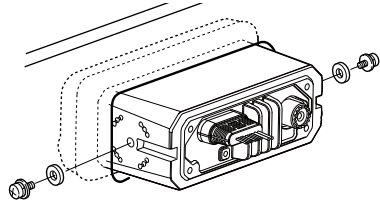

9

4. Attach the clamps on both sides of the transceiver.
  - ⓘ Make sure that the clamps align parallel to the transceiver body.

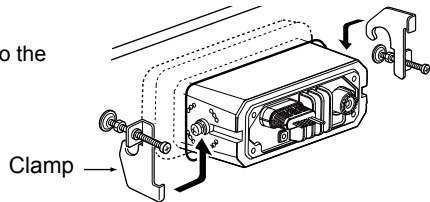

5. Tighten the end bolts on the clamps (rotate clockwise) so that the clamps press firmly against the inside of the instrument control panel.

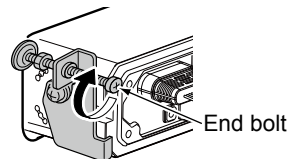

6. Tighten the locking nuts (rotate counterclockwise) so that the transceiver is securely mounted in position, as shown to the right. (Torque: 2 N•m)

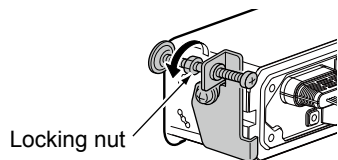

7. Connect the antenna and power cable.

# 10 SPECIFICATIONS AND OPTIONS

## ■ Specifications

① All stated specifications are subject to change without notice or obligation.

General	
Frequency coverage	TX: 156.025 ~ 157.425 MHz RX: 156.050 ~ 163.275 MHz CH70: 156.525 MHz
Mode	16K0G3E (FM), 16K0G2B (DSC)
Channel spacing	25 kHz
Operating temperature range	-20°C ~ +60°C, -4°F ~ +140°F
Current drain (at 13.8 V)	TX high (25 W): Less than 5 A Maximum audio: Less than 1.2 A
Power supply requirement	Negative ground: 13.8 V DC (11.7 ~ 15.9 V)
Frequency tolerance	±5 ppm
Antenna impedance	50 Ω nominal
Dimensions (approximately, projections not included)	156.5 (W) × 66.5 (H) × 110.1 (D) mm 6.2 (W) × 2.6 (H) × 4.3 (D) in
Weight (approximately)	700 g, 1.5 lb (including microphone)
Transmitter	
Output power	25 W or 1 W
Modulation system	FSK Modulation
Maximum frequency deviation	±5 kHz
Spurious emissions	Less than -60 dBc
Receiver	
Receive system	Direct conversion system
Sensitivity	FM: 0.22 μV (typical) at 12 dB SINAD DSC (CH70): -5 dBμ emf (typical) (1% BER)
Squelch sensitivity	Less than 0.32 μV
Intermodulation rejection ratio	FM: More than 63 dB DSC (CH70): More than 55 dBμ emf (1% BER)
Adjacent channel selectivity	FM: More than 68 dB DSC (CH70): More than 68 dBμ emf (1% BER)
Audio output power (at 10% distortion into a 4 Ω load)	Internal: More than 2 W External: Typical 4.5 W
GPS (For only the IC-M220G)	
Frequency	1575.42 MHz
Channel	Acquisition, tracking: Maximum 24 ch Calculation: Maximum 12 ch
Deferential satellites	WAAS, EGNOS, MSAS, GAGAN
GLONASS receiving frequency	1598.0625 MHz ~ 1605.375 MHz

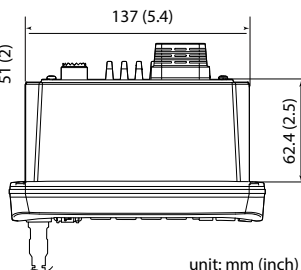
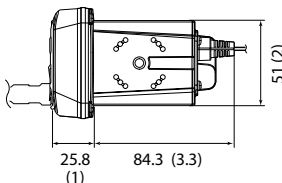
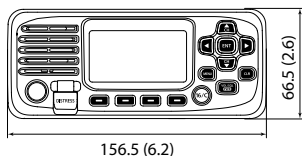

unit: mm (inch)

## ■ Options

- **MBF-5** FLUSH MOUNT KIT  
To mount the transceiver to a panel.
- **HM-237B** MICROPHONE
- **MA-510TR** CLASS B AIS TRANSPONDER  
To transmit individual DSC calls to a selected AIS targets.

## The transceiver does not turn ON.

- There is a bad connection to the power supply.  
→ Check the connection to the transceiver and power supply. (p. 44)
- The fuse is blown.  
→ Repair the problem, and then replace the fuse. (p. 45)

## Little or no sound comes from the speaker.

- Squelch level is set too high.  
→ Set the squelch to the threshold point. (p. 9)
- Volume level is set too low.  
→ Set the volume level to a suitable level. (p. 9)

## You cannot transmit with high power.

- Some channels are set for low power or receive only by regulations.  
→ Change channels. (p. 7)
- The output power is set to low.  
→ Push  to select high power. (p. 5)

## Scan does not start.

- More than 2 favorite channels are not set.  
→ Set at least 2 favorite channels. (p. 13)

## No beep sounds.

- The Key Beep function is OFF.  
→ Turn ON the function. (p. 38)

## Individual or Group ID cannot be set.

- The entered ID code is incorrect. The first digit must be set to between '1' and '9' for an Individual ID.  
→ Enter a correct ID code. (p. 15)

## “??” blinks instead of the position and time.

- Four hours have passed since you manually entered the position.  
→ Re-enter the position and time. (p. 16)
- The GPS position is invalid.  
→ Enter the position and time. (p. 16)

## “NO POS” and “NO TIME” are displayed instead of the position and time.

- The GPS signal is not correctly received.  
→ Check the transceiver is located where it has a clear view to receive signal from satellites. (p. 46)  
→ Check the cable connection to NMEA In/Out leads. (p. 44)
- The position and time have not been manually entered.  
→ Enter the position and time. (p. 16)

# 12 CHANNEL LIST

Channel Number			Frequency (MHz)	
USA	INT	CAN	Transmit	Receive
	01	01	156.050	160.650
01A	01A		156.050	156.050
	02	02	156.100	160.700
	03	03	156.150	160.750
	04		156.200	160.800
		04A	156.200	156.200
	05		156.250	160.850
05A	05A	05A	156.250	156.250
06	06	06	156.300	156.300
	07		156.350	160.950
07A	07A	07A	156.350	156.350
08	08	08	156.400	156.400
09	09	09	156.450	156.450
10	10	10	156.500	156.500
11	11	11	156.550	156.550
12	12	12	156.600	156.600
13* <sup>1</sup>	13	13* <sup>2</sup>	156.650	156.650
14	14	14	156.700	156.700
15* <sup>3</sup>	15* <sup>2</sup>	15* <sup>2</sup>	156.750	156.750
16	16	16	156.800	156.800
17* <sup>2</sup>	17	17* <sup>2</sup>	156.850	156.850
	18		156.900	161.500
18A	18A	18A	156.900	156.900
	19		156.950	161.550
19A	19A	19A	156.950	156.950
	19B		RX only	161.550
20	20	20* <sup>2</sup>	157.000	161.600
20A	20A		157.000	157.000
	20B		RX only	161.600
	21		157.050	161.650
21A	21A	21A	157.050	157.050
		21B	RX only	161.650
	22		157.100	161.700
22A	22A	22A	157.100	157.100
	23	23	157.150	161.750
23A	23A		157.150	157.150
		23B	RX only	161.750
24		24	157.200	161.800
25		25	157.250	161.850
		25B	RX only	161.850
26		26	157.300	161.900
27	27	27	157.350	161.950
	27A		157.350	157.350
28	28	28	157.400	162.000
	28A		157.400	157.400
		28B	RX only	162.000
	60	60	156.025	160.625
	61		156.075	160.675
		61A	156.075	156.075

Channel Number			Frequency (MHz)	
USA	INT	CAN	Transmit	Receive
	62		156.125	160.725
		62A	156.125	156.125
	63		156.175	160.775
63A	63A	63A	156.175	156.175
	64	64	156.225	160.825
		64A	156.225	156.225
	65		156.275	160.875
65A	65A	65A* <sup>2</sup>	156.275	156.275
	66		156.325	160.925
66A	66A	66A* <sup>2</sup>	156.325	156.325
67* <sup>1</sup>	67	67	156.375	156.375
68	68	68	156.425	156.425
69	69	69	156.475	156.475
71	71	71	156.575	156.575
72	72	72	156.625	156.625
73	73	73	156.675	156.675
74	74	74	156.725	156.725
	75* <sup>2</sup>	75* <sup>2</sup>	156.775	156.775
	76* <sup>2</sup>	76* <sup>2</sup>	156.825	156.825
77* <sup>2</sup>	77	77* <sup>2</sup>	156.875	156.875
	78		156.925	161.525
78A	78A	78A	156.925	156.925
	78B		RX only	161.525
	79		156.975	161.575
79A	79A	79A	156.975	156.975
	79B		RX only	161.575
	80		157.025	161.625
80A	80A	80A	157.025	157.025
	81		157.075	161.675
81A	81A	81A	157.075	157.075
	82		157.125	161.725
82A	82A	82A	157.125	157.125
	83		157.175	161.775
83A	83A	83A	157.175	157.175
		83B	RX only	161.775
84		84	157.225	161.825
85		85	157.275	161.875
86		86	157.325	161.925
87	87	87	157.375	157.375
88	88	88	157.425	157.425

\*<sup>1</sup> Momentary high power.

\*<sup>2</sup> Low power only.

\*<sup>3</sup> RX only.

**NOTE:** When the "CH Display" setting in the Menu screen is set to "4 Digits," the channel number is displayed in 4 digits. (For example: "01A" is displayed as "1001.")



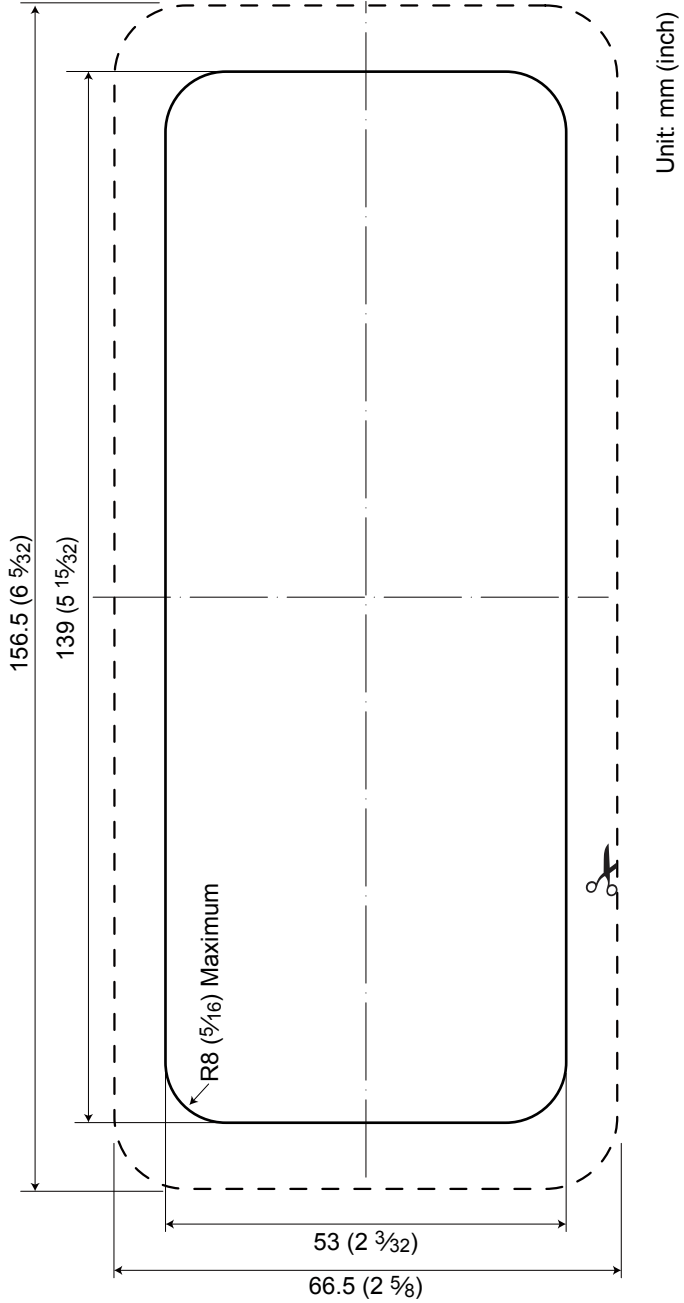

12  
13



- A**
- Alarm Status (DSC Settings)..37
  - All Ships call
    - Receiving.....30
    - Sending.....22
  - Antenna.....45
  - AquaQuake.....11
  - Auto ACK (DSC Settings)..36
- B**
- Backlight.....9
  - Configuration.....40
- C**
- Call channel
    - Radio Settings.....41
    - Selecting.....7
    - Setting.....10
  - CH 70 SQL Level, DSC
    - Settings.....37
  - Channel
    - Group.....7
    - Name, editing.....11
    - Selecting.....7
  - Channel 16.....7
  - CH Auto Switch, DSC
    - Settings.....36
  - CH Close-up
    - Radio settings.....42
  - CH Display
    - Radio settings.....41
  - Connections.....44
  - Contrast.....9
- D**
- Display Contrast
    - Configuration.....40
  - Distress call
    - Cancel call.....19
    - Receiving.....28
    - Regular call.....18
    - Sending.....17
    - Simple call.....17
    - Software Key.....19
  - DSC
    - Address ID.....15
    - Log, received.....33
    - Log, transmitted.....33
    - Settings.....36
  - DSC data output.....36
  - Dual/Tri-watch
    - Radio Settings.....41
  - Dualwatch.....14
- F**
- Favorite channels.....13
  - FAV Settings
    - Radio Settings.....41
  - Front panel.....2
  - Function display.....3, 4
  - Fuse replacement.....45
- G**
- GPS
    - Configuration.....40
  - Group call
    - Receiving.....30
    - Sending.....23
  - Group ID
    - Deleting.....16
    - DSC setting.....36
- I**
- ICONS.....3, 4
  - Inactivity Timer
    - Configuration.....40
  - Individual Acknowledgement
    - Sending.....21
  - Individual call
    - Receiving.....29
    - Sending.....20
  - Individual ID
    - Deleting.....16
    - DSC Settings.....36
    - Entering.....15
- K**
- Key Assignment
    - Configuration.....40
  - Key Beep
    - Configuration.....40
- M**
- MA-510TR
    - Connecting.....45
  - MBF-5 installation.....47
  - Menu screen
    - Items.....39
    - Using.....38
  - Microphone.....2
    - Connecting.....43
  - MMSI code, entering.....6
  - Mounting the transceiver...46
  - Multiple-task mode.....34
- O**
- Options.....48
- P**
- Position
    - Entering.....16
    - Input (DSC Settings).....36
    - Reply call, sending.....27
    - Request call, receiving...31
    - Request call, sending...26
  - Procedure (DSC Settings)..37
- R**
- Radio Info, Menu screen...42
  - Receiving.....10
- S**
- Scan
    - Priority.....12
    - Starting.....13
    - Types.....12
  - Scan Timer
    - Radio Settings.....41
  - Scan Type
    - Radio Settings.....41
  - Self test (DSC Settings)....37
  - Simple call, Distress call...17
  - Software Keys.....4
  - Specifications.....48
  - Squelch level.....9
- T**
- Template.....51
  - Test Acknowledgement
    - Sending.....25
  - Test call
    - Receiving.....32
    - Sending.....24
  - Time, entering.....16
  - Transmitting.....10
  - Tri-watch.....14
- U**
- UTC Offset
    - Configuration.....40
- V**
- Volume level.....9
- W**
- Weather Alert.....8
  - Weather channels.....8
  - WX Alert
    - Radio Settings.....41

**Count on us!**

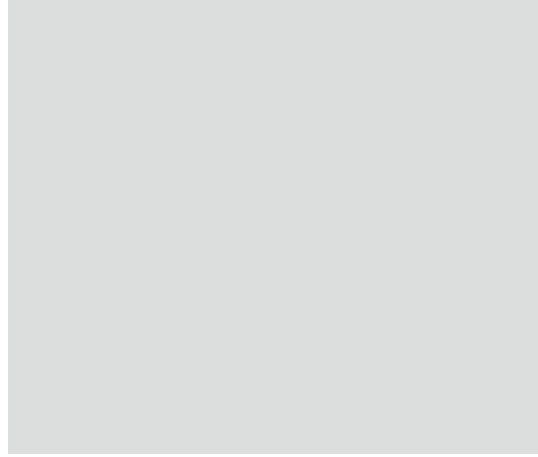

A7466H-1EX-1  
Printed in Japan

© 2018–2021 Icom Inc. Aug. 2021

**Icom Inc.**

1-1-32 Kamiminami, Hirano-ku,  
Osaka 547-0003, Japan

## ■ Making an Individual call using an AIS transponder

When the optional MA-510TR CLASS B AIS TRANSPONDER is connected to your transceiver, you can transmit an Individual DSC call to a selected AIS target, without entering the target's MMSI code. In this case, the call type is automatically set to "Routine."

① See page 45 for connecting instructions.

**NOTE:** To ensure correct operation of the DSC function, make sure you correctly set the CH70 SQL Level. (p.37)

### Transponder operation:

1. Select an AIS target on the plotter, target list or danger list display.  
① See the MA-510TR instruction manual for details.
2. Push [ENT] to display the Menu window.
  - The Menu window is displayed.
3. Select "Send DSC," and then push [ENT].
  - The "DSC TRANSMISSION" screen is displayed.

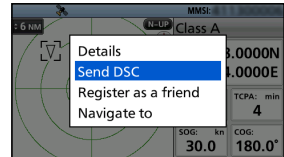

4. Push [▲] or [▼] to select a voice channel.
  - Voice channels are already preset into the transponder in the recommended order.

**NOTE:** When a base station is selected in step 1, a voice channel will be specified by the base station. Therefore, you cannot change the channel. The transponder will display "Voice Channel is specified by the Base station," in this case.

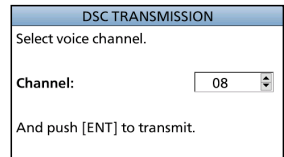

5. Push [ENT] to make the Individual DSC call.
  - "Transmitting individual call" is displayed.
  - ① If Channel 70 is busy, the transceiver stands by until the channel becomes clear.
6. After making the Individual DSC call, "DSC transmission completed." is displayed.
  - If the transceiver cannot make the call, "DSC transmission failed." is displayed.
  - The transceiver stands by on Channel 70 until an Acknowledgement is received.

---

## APPENDIX

### Transceiver operation:

7. When the Acknowledgement is received, an alarm sounds.
  - If the acknowledgment 'Able to comply' is received, push **ALARM OFF** to turn OFF the alarm, and then select the voice channel specified in step 4.
    - A different voice channel will be selected if the station you called cannot use the channel.
    - To reply, push [PTT] and speak at your normal voice level.
    - You can check the MMSI code or the name, if entered, of the AIS target on the display.
  - If the acknowledgment 'Unable to comply' is received, push **ALARM OFF** to turn OFF the alarm, then the Acknowledge information is displayed.
8. After the communication is finished, push **STBY** to return to the operating screen.

